

EUROMASK®



SILICONE ADHESIVE - NASTRI CARTA - STAMPATI SPECIALI - BIADESIVI
TAPPI - HOOKS - NASTRI ADESIVI - CAPS - STAMPATI SPECIALI - CUT

EMMK

CORDS - CAPPUCCI - SILICONE FOAMS - GANCI - DIE CUTS - PLUGS - FLT
POLYIMIDE TAPES - AUTOAGGLOMERANTE - SPECIAL ENGINEERED - EPDM



Powered by
FINISHING GROUP srl



Sistema Qualità Certificato
Certified Quality System

RELEASE
**EMK
K22 E**

**"WE SOLVE
EVERY MASKING
PROBLEM"**

EUROMASK®



Euromask® è leader nella produzione e distribuzione di sistemi professionali di mascheratura per tutti i trattamenti superficiali. Da ormai 20 anni, Euromask® distribuisce in tutto il mondo la sua ampia gamma di tappi, cappucci, ganci per la verniciatura, nastri e bollini, tubi e prodotti stampati speciali.

Velocità, flessibilità e professionalità sono le parole chiave del successo di Euromask®:

- Evasione dell'85% degli ordini in 24/48 ore
- 130 milioni di pezzi a magazzino
- Campionatura in tempi brevi: per gli adesivi in 3-4 giorni e produzione in 10 di giorni, per gli stampati in 1 settimana e produzione in 4 settimane.

Sistemi di mascheratura per le operazioni di verniciatura a polvere, liquido, anodizzazione e cromatura. Tappi conici e cappucci per la protezione di fori e filetti nelle operazioni di verniciatura, resistenti fino a 315°C. e riutilizzabili. Nastri e bollini adesivi per le operazioni di verniciatura a polveri e nei processi galvanici, metallizzazione e anodizzazione.

Condizioni di vendita: Spedizione a mezzo corriere espresso. Ordine minimo € 75,00

**Schede tecniche disponibili a richiesta
Catalogo valido da Ottobre 2021**

Finishing Group s.r.l. si riserva il diritto di apportare modifiche ai prodotti, prezzi e condizioni di fornitura senza alcun preavviso.

WE SOLVE EVERY MASKING PROBLEM



Euromask® is a leader in the production and distribution of professional masking systems for all surface treatments. Since 20 years Euromask® has been distributing its wide range of plugs, caps and painting hooks, tapes and discs, tubing and special moulded products worldwide.

Speed, flexibility and professionalism are the key words to Euromask®'s success:

- Execution of 85% of orders within 24/48 hours
- 130 million pieces in stock
- Fast sampling times: for adhesives 3-4 days with production in about ten days, for moulded items 1 week with production in 4 weeks.

Masking systems for powder and liquid painting operations, anodizing and chromium plating. Conical plugs and caps for the protection of holes and threads in painting operations. Resisting up to 315°C. and reusable. Tapes and adhesive disks for masking operations in powder painting and galvanic processes, metallization and anodizing.

Sales Terms: Shipment by express carrier. Minimum order € 75,00

**Technical data sheets availables on demand
Catalog available from October 2021**

Finishing Group s.r.l. reserve to make any necessary modification to products, prices and supply conditions without notice.

HOOKS

Altre forme e dimensioni realizzabili a richiesta
Other sizes and drawings on demand



Ganci in acciaio e ferro per verniciatura.



Steel and iron hooks for painting.



HC



HV

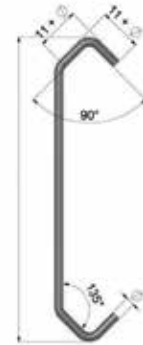

TIPO 5

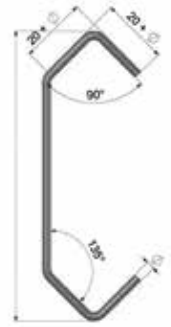

TIPO 6

LUNGH LENGTH	Ø 1,5 mm Q.ty	Ø 2 mm Q.ty	Ø 3 mm Q.ty	Ø 4 mm Q.ty	Ø 5 mm Q.ty
60 mm	5000	5000	2500	1500	1000
75 mm	5000	5000	2000	1000	500
100 mm	5000	3000	2000	1000	500
150 mm	2500	2500	1500	500	500
200 mm	2000	1500	1000	500	250
250 mm	1000	1000	1000	500	250
300 mm	500	500	750	500	250
350 mm	500	500	750	500	250
400 mm	500	500	750	250	250

piega-bend-pivotée-Verdrehung-plega: 45° - 90° - 180° - **PREZZO - PRICE : +15%**

SW



Ganci girevoli.



Swivel hooks.

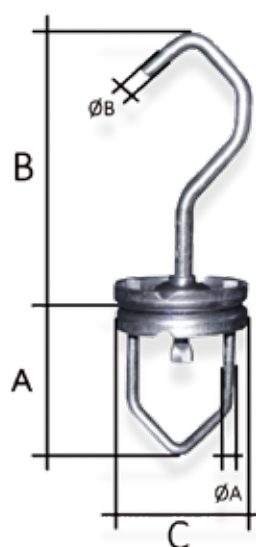

CODICE CODE	A	B	C	D	Ø A	Ø B
sw V	60	100	49,5	-	5	7
sw V crown	60	100	88	-	5	7
sw C	53	75	47,7	17,5	5	6

H-VERT

Altre forme
e dimensioni
realizzabili a richiesta
Other sizes and drawings
on demand

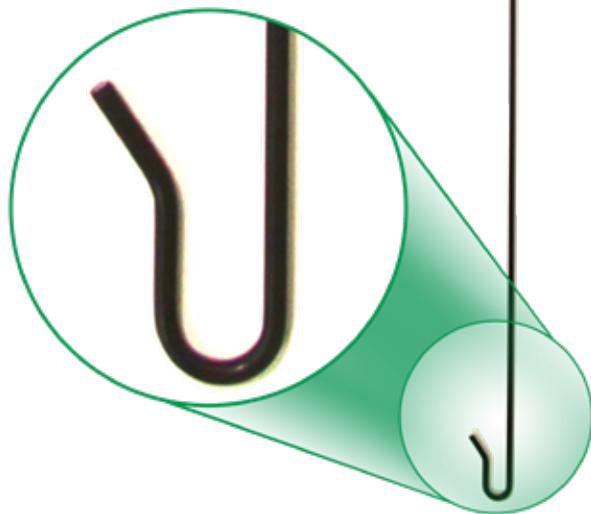

Ganci in acciaio per verniciatura in verticale di profili in alluminio.



Steel hooks for vertical painting of Aluminium profiles.

Ganci Speciali

Special Hooks



Ganci Speciali.

Produzione di grossi o piccoli volumi realizzati a disegno del cliente. Rapidità di approntamento. Adatti per verniciatura e saldatura.



Special Hooks.

Low or High volume quantities. Made on customer's bespoke drawings. Fast turnaround. Suitable for painting and welding.

CUT



Distributore automatico taglianastro.
Taglio spezzoni da 20 a 999 mm di nastri adesivi larghi da 8 a 50 mm



Automatic tape-cut dispenser.
To cut adhesive tape pieces from 20 to 999mm LENGTH and from 8 to 50mm width

TAI

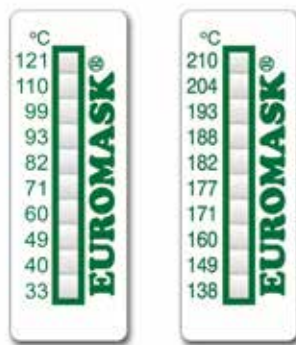

Termometri autoadesivi monouso.
Graduati per controllo della temperatura all'interno del forno.



Self-adhesive thermometers (single-use).
Graded for temperature control inside the oven.

**CODICE
CODE**

TAI010 (10 pz)
TAI009 (10 pz)

**SCALA
RANGE**

138 °C - 210 °C
33°C - 121 °C

STICKRP01



Stick per ritocco verniciatura a polvere.



Custom made touch-up pencils for powder coating

**CODICE
CODE**

STICKRP01
STICKRP01
STICKRP01

**PZ. SCAT.
PCS. BOX**

fino a 50 PZ / up to 50 PCS
fino a 100 PZ / up to 100 PCS
fino a 250 PZ / up to 250 PCS

PRO



Vernice spray HQS.

Studiata per il ritocco professionale. Ampia gamma di colori RAL. Elevata durata nel tempo senza ingiallire, senza cambiare colore e senza staccarsi dal materiale.



Spray paint HQS.

Sudied for professional retouching work. Wide range of RAL colors. High long-time resistance without yellowing, without changing color and without detaching from the material.



CODICE CODE	COLORI COLOURS	PZ. CONF. PCS. BOX
PRO	Colori vari RAL - <i>Various RAL colours</i>	6
PROTRASP	Trasparente opaco o lucido - <i>Glossy transparent or opaque</i>	6
PRO9006	Argento - <i>Silver</i>	6
PRO-ANT	Antiruggine / Bianco / Grigio / Rosso <i>Antirust / White / Grey / Rusty red</i>	6

SRT

15mts



IT

Nastro silicone autoagglomerante.

Nastro in silicone senza adesivo. Il nastro fondendosi su se stesso forma una pellicola omogenea resistente fino a 300 °C. Il nastro ha tempi di stoccaggio limitati.



Self-agglomerating silicone rubber tape.

Silicone rubber tape without adhesive. The tape vulcanized on itself, forms an homogeneous cover that can withstand temperatures of up to 300°C. Limited shelf life.

**CODICE
CODE**
SRT25

**ALTEZZA
SIZE**
25 mm

**LUNGH.
LENGTH**
15 m

**PZ. SCAT.
RLS BOX**
20

AAP

250mts

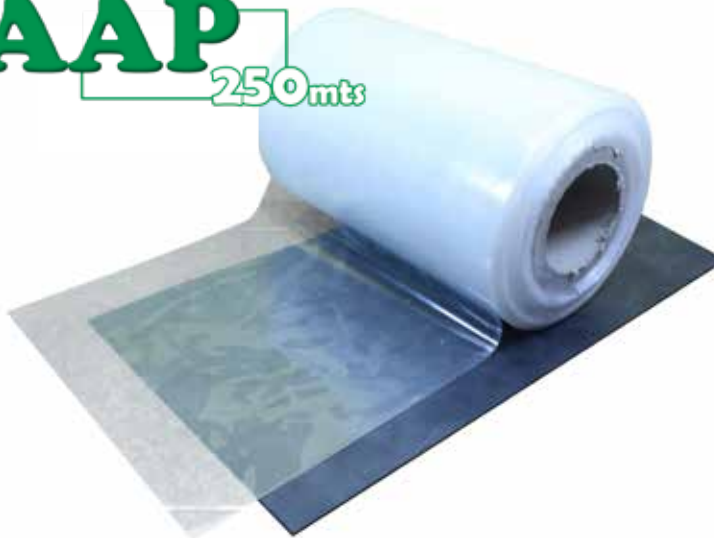

IT

Pellicola autoadesiva trasparente

Per la protezione delle cabine di verniciatura a liquido.



Transparent self-adhesive film

For the protection of liquid spray booths.

**CODICE
CODE**

**ALTEZZA
SIZE**

**LUNGH.
LENGTH**

AAP1180-250

300 mm

250 m

AAP1575-250

400 mm

250 m

AAP1970-250

500 mm

250 m

WE SOLVE EVERY MASKING PROBLEM

HPT

55mts

Altezze e prezzi
disponibili a richiesta
Sizes and prices
available on demand

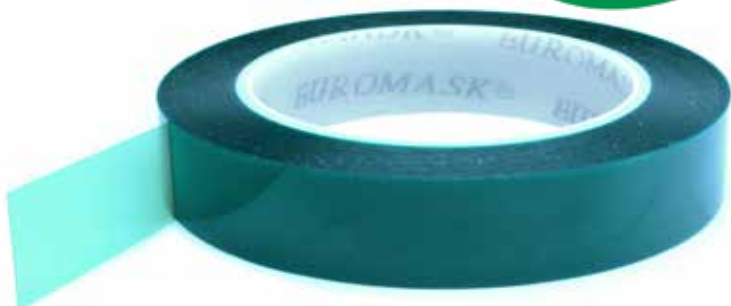

SERVIZIO DI TAGLIO NASTRO CON MISURE A RICHIESTA. ALTEZZE DISPONIBILI DA 3 A 1105 mm CON PASSO 1 mm
BESPOKEN THICKNESS CUT SERVICE. SIZE BETWEEN 3 TO 1105 mm, STEP BY 1 mm



Nastro verde 204 °C

Per rivestimenti a polvere e applicazioni di anodizzazione. Una volta rimosso lascia una superficie pulita, senza residui di adesivo. 0,05 mm di poliestere - 0,04 mm di adesivo.



Green tape 204 °C

Powder coating and anodizing applications. Clean removal, no adhesive residue. 0,05 mm polyester - 0,04 mm silicone adhesive.

EPR

66mts

Altezze e prezzi
disponibili a richiesta
Sizes and prices
available on demand



SERVIZIO DI TAGLIO NASTRO CON MISURE A RICHIESTA. ALTEZZE DISPONIBILI DA 3 A 1105 mm CON PASSO 1 mm
BESPOKEN THICKNESS CUT SERVICE. SIZE BETWEEN 3 TO 1105 mm, STEP BY 1 mm



Nastro rosso 220°C

Per rivestimenti a polvere e applicazioni di anodizzazione. Una volta rimosso lascia una superficie pulita, senza residui di adesivo. 0,025 mm di poliestere - 0,07 mm di adesivo



Red tape 220 °C

Powder coating and anodizing applications. Clean removal, no adhesive residue. 0,025 mm polyester - 0,07 mm silicone adhesive.

EPB

66mts

Altezze e prezzi
disponibili a richiesta
Sizes and prices
available on demand

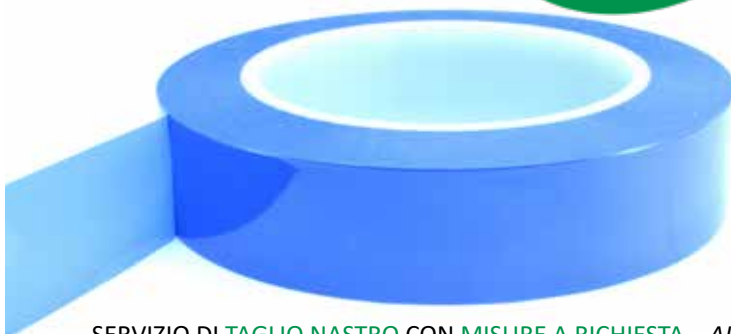

SERVIZIO DI TAGLIO NASTRO CON MISURE A RICHIESTA. ALTEZZE DISPONIBILI DA 3 A 1105 mm CON PASSO 1 mm
BESPOKEN THICKNESS CUT SERVICE. SIZE BETWEEN 3 TO 1105 mm, STEP BY 1 mm



Nastro Blu 204 °C

Per rivestimenti a polvere e applicazioni di anodizzazione. Adatto alle superfici curve. Una volta rimosso lascia una superficie pulita, senza residui di adesivo. 0,025 mm di poliestere - 0,05 mm di adesivo.



Blue tape 204 °C

Powder coating and anodizing applications. Suitable for curved surfaces. Clean removal, no adhesive residue. 0,025 mm polyester 0,045 mm silicone adhesive.

EPTL

500mt

Altezze e prezzi
disponibili a richiesta
Sizes and prices
available on demand

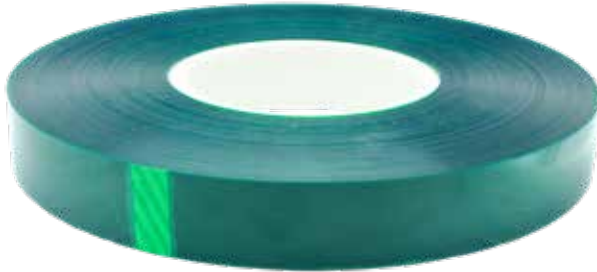

IT

Nastro verde 204 °C

Per rivestimenti a polvere e applicazioni di anodizzazione. Una volta rimosso lascia una superficie pulita, senza residui di adesivo. 0,05 mm di poliestere - 0,04 mm di adesivo.

GB

Green tape 204 °C

Powder coating and anodizing applications. Clean removal, no adhesive residue. 0,05 mm polyester - 0,04 mm silicone adhesive.

SERVIZIO DI TAGLIO NASTRO CON MISURE A RICHIESTA. ALTEZZE DISPONIBILI DA 15 A 480 mm CON PASSO 1 mm
BESPOKEN THICKNESS CUT SERVICE. SIZE BETWEEN 15 TO 480 mm, STEP BY 1 mm

STC

66mts

Altezze e prezzi
disponibili a richiesta
Sizes and prices
available on demand



IT

Nastro trasparente 204 °C.

Per rivestimenti a polvere e applicazioni di anodizzazione. Adatto per superfici curve. Una volta rimosso lascia una superficie pulita, senza residui di adesivo. 0,025 mm di poliestere - 0,04 mm di adesivo.

GB

Clear tape 204 °C.

Powder coating and anodizing applications. Adapted to curved surfaces. Clean removal, no adhesive residue. 0,025 mm polyester, 0,04 mm silicone adhesive.

SERVIZIO DI TAGLIO NASTRO CON MISURE A RICHIESTA. ALTEZZE DISPONIBILI DA 3 A 1105 mm CON PASSO 1 mm
BESPOKEN THICKNESS CUT SERVICE. SIZE BETWEEN 3 TO 1105 mm, STEP BY 1 mm

CLT

66mts

Altezze e prezzi
disponibili a richiesta
Sizes and prices
available on demand



IT

Nastro trasparente 204 °C.

Per rivestimenti a polvere e applicazioni di anodizzazione. Una volta rimosso lascia una superficie pulita, senza residui di adesivo. 0,05 mm di poliestere - 0,04 mm di adesivo.

GB

Clear tape 204 °C.

Powder coating and anodizing applications. Clean removal, no adhesive residue. 0,05 mm polyester - 0,04 mm silicone adhesive.

SERVIZIO DI TAGLIO NASTRO CON MISURE A RICHIESTA. ALTEZZE DISPONIBILI DA 3 A 1105 mm CON PASSO 1 mm
BESPOKEN THICKNESS CUT SERVICE. SIZE BETWEEN 3 TO 1105 mm, STEP BY 1 mm

WE SOLVE EVERY MASKING PROBLEM

PC
33mts

Altezze e prezzi
disponibili a richiesta
Sizes and prices
available on demand



SERVIZIO DI TAGLIO NASTRO CON MISURE A RICHIESTA. ALTEZZE DISPONIBILI DA 3 A 1000 mm CON PASSO 1 mm
BESPOKEN THICKNESS CUT SERVICE. SIZE BETWEEN 3 TO 1000 mm, STEP BY 1 mm



Nastro polimide 260 °C.

Per rivestimenti a polvere ed elettrostatici per immersione liquida. Una volta rimosso lascia una superficie pulita, senza residui. Ottima resistenza chimica. 0,025 mm di polimide 0,04 mm di adesivo silconico.



Polyimide tape 260 °C.

Recommended for powder coating and E-coating. Clean removal, no adhesive residue. Excellent chemical resistance. 0,025 mm polyimide - 0,04 mm silicone adhesive.

EGC
50mts

Altezze e prezzi
disponibili a richiesta
Sizes and prices
available on demand



SERVIZIO DI TAGLIO NASTRO CON MISURE A RICHIESTA. ALTEZZE DISPONIBILI DA 3 A 1075 mm CON PASSO 1 mm
BESPOKEN THICKNESS CUT SERVICE. SIZE BETWEEN 3 TO 1075mm, STEP BY 1 mm



Nastro in tessuto di fibra-vetro 260 °C.

Indicato per la flammizzazione e per rivestimenti a polvere. Resistente alla sabbiatura ad alta pressione, all'abrasione e ai solventi.



Glass Cloth tape 260 °C.

Recommended for thermal spray and powder coating. Resistant to high pressure blasting, abrasion and to solvents.

FLT
33mts

Altezze e prezzi
disponibili a richiesta
Sizes and prices
available on demand

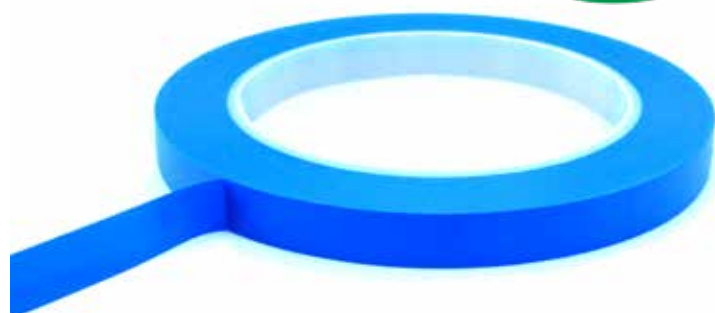

SERVIZIO DI TAGLIO NASTRO CON MISURE A RICHIESTA. ALTEZZE DISPONIBILI DA 3 A 1200mm CON PASSO 1 mm
BESPOKEN THICKNESS CUT SERVICE. SIZE BETWEEN 3 TO 1200mm, STEP BY 1 mm



Nastro Fine Line Tape

Nastro in pvc con adesivo in gomma. Resistente al calore fino a 155°C. Indicato per lavorazioni complesse per la sua conformabilità.



High Temperature Fine Line Tape

PVC film with rubber adhesive, high conformability and a smooth, sharp mask-off edge. The blended rubber based adhesive system offers high temperature resistance up to 155°C.

RPT

66mts

Altezze e prezzi
disponibili a richiesta
Sizes and prices
available on demand

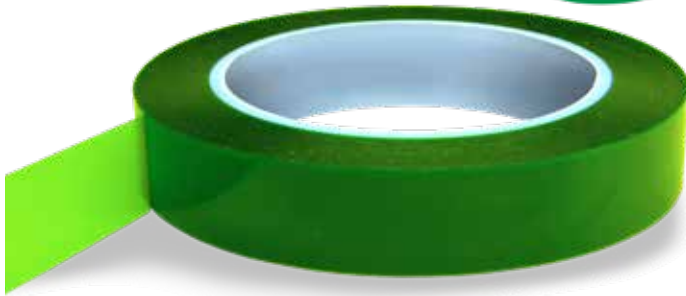

IT

Nastro verde 190 °C.

Per rivestimenti a polvere e applicazioni di anodizzazione. Una volta rimosso lascia una superficie pulita, senza residui. 0,05 mm di poliestere - 0,04 mm di adesivo in gomma.

GB

Green tape 190 °C.

Recommended for powder coating and anodizing applications. Clean removal, no adhesive residue.

0,05mm polyester - 0,04mm rubber adhesive

SERVIZIO DI TAGLIO NASTRO CON MISURE A RICHIESTA. ALTEZZE DISPONIBILI DA 3 A 1105 mm CON PASSO 1 mm
BESPOKEN THICKNESS CUT SERVICE. SIZE BETWEEN 3 TO 1105 mm, STEP BY 1 mm

LALL65

50mts

Altezze e prezzi
disponibili a richiesta
Sizes and prices
available on demand



IT

Nastro in alluminio

Spessore 65µ. Accoppiato con liner in carta. Con adesivo acrilico ad alte prestazioni. Indicato per applicazioni elettriche e termiche. Ottima resistenza alla flammatura.

GB

Aluminium tape

65µ tape Aluminium. coupled with paper liner. With high performance's acrylic adhesive. Particularly suitable for electrical and thermal applications. Good flame hardening resistant.

SERVIZIO DI TAGLIO NASTRO CON MISURE A RICHIESTA. ALTEZZE DISPONIBILI DA 10 A 400 mm CON PASSO 1 mm
BESPOKEN THICKNESS CUT SERVICE. SIZE BETWEEN 10 TO 400 mm, STEP BY 1 mm

LALL70

100mts

Altezze e prezzi
disponibili a richiesta
Sizes and prices
available on demand



IT

Nastro in alluminio laminato PET

Spessore 70µ. Nastro laminato PET con adesivo acrilico ad alte prestazioni. Indicato per applicazioni elettriche e termiche.

GB

Aluminium tape PET laminated

70µ tape Aluminium. PET laminated with acrylic adhesive with high performance. Particularly suitable for electrical and thermal applications.

SERVIZIO DI TAGLIO NASTRO CON MISURE A RICHIESTA. ALTEZZE DISPONIBILI DA 10 A 1270 mm CON PASSO 1 mm
BESPOKEN THICKNESS CUT SERVICE. SIZE BETWEEN 10 TO 1270 mm, STEP BY 1 mm

WE SOLVE EVERY MASKING PROBLEM

SPG

50mts

Altezze e prezzi
disponibili a richiesta
Sizes and prices
available on demand



Nastro in carta alta temperatura 190 °C.
Indicato per verniciatura a polvere.
Lascia una superficie pulita senza residui.



High temperature masking tape 190 °C.
Recommended for powder coating.
Clean removal.

SERVIZIO DI TAGLIO NASTRO CON MISURE A RICHIESTA. ALTEZZE DISPONIBILI DA 3 A 1230 mm CON PASSO 1 mm
BESPOKEN THICKNESS CUT SERVICE. SIZE BETWEEN 3 TO 1230 mm, STEP BY 1 mm

EPG

50mts

Altezze e prezzi
disponibili a richiesta
Sizes and prices
available on demand



Nastro per mascheratura 140 °C.
Indicato per verniciatura a liquido, lascia una
superficie pulita senza residui.



Masking tape 140 °C.
Recommended for painting. Clean removal.

SERVIZIO DI TAGLIO NASTRO CON MISURE A RICHIESTA. ALTEZZE DISPONIBILI DA 3 A 1550 mm CON PASSO 1 mm
BESPOKEN THICKNESS CUT SERVICE. SIZE BETWEEN 3 TO 1550 mm, STEP BY 1 mm

LPG

50mts

Altezze e prezzi
disponibili a richiesta
Sizes and prices
available on demand



Nastro in carta per mascheratura 80°C.
Indicato per verniciatura a liquido a
bassa temperatura, lascia la superficie
pulita senza residui.



Semi creped paper masking tape 80°C.
Recommended for liquid coating at low
temperature. Good adhesion on irregular
surfaces and no adhesive residual.

SERVIZIO DI TAGLIO NASTRO CON MISURE A RICHIESTA. ALTEZZE DISPONIBILI DA 3 A 1410 mm CON PASSO 1 mm
BESPOKEN THICKNESS CUT SERVICE. SIZE BETWEEN 3 TO 1410 mm, STEP BY 1 mm

EPCL



IT

Bollino adesivo con linguetta 204 °C.



Adhesive discs with tab 204 °C.

CODICE CODE	DIAM. mm DIAM mm	PZ ROLL PCS. ROLL
EPCL10	10	2000
EPCL15	15	2000
EPCL20	20	1000
EPCL25	25	500
EPCL30	30	500
EPCL35	35	500
EPCL45	45	500
EPCL50	50	250
EPCL60	60	250
EPCL70	70	250

REALIZZAZIONE BOLLINI CON DIAMETRI A RICHIESTA

QPL

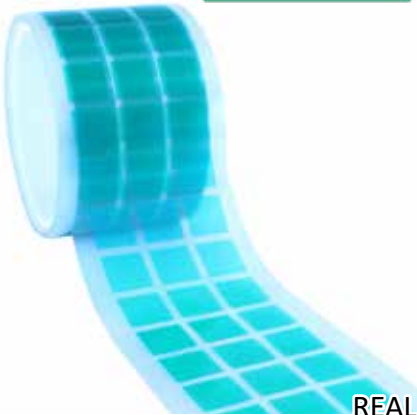

IT

Quadrati in nastro verde 204 °C.



Squares green tape 204 °C.

ALCUNI ESEMPI
some examples

CODICE CODE	DIAM. mm DIAM mm	PZ ROLL PCS. ROLL
QPL5x5	5x5	1000
QPL10x10	10x10	1000
QPL50x50	50x50	1000
QPL100x100	100x100	250
QPL150x150	150x150	100

REALIZZAZIONE QUADRATI ADESIVI CON MISURE A RICHIESTA FINO A LATO 500mm

RPL

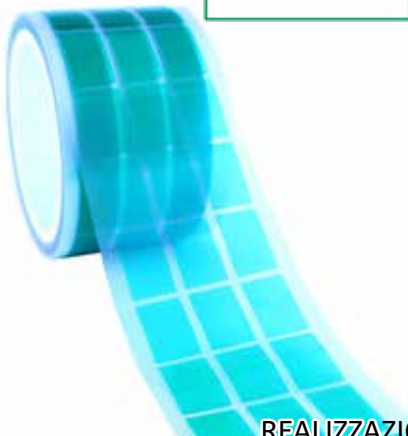

IT

Rettangoli in nastro verde 204 °C.



Rectangles green tape 204 °C.

ALCUNI ESEMPI
some examples

CODICE CODE	DIAM. mm DIAM mm	PZ ROLL PCS. ROLL
RPL5x10	5x10	1000
RPL10x50	10x50	1000
RPL25x100	25x100	1000
RPL50x150	50x150	1000
RPL100x200	100x200	100

REALIZZAZIONE RETTANGOLI ADESIVI CON MISURE A RICHIESTA FINO A LATI 500x1000mm

WE SOLVE EVERY MASKING PROBLEM

EPC

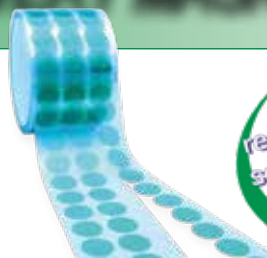

Altre dimensioni
realizzabili a richiesta
senza costi aggiuntivi
Other sizes on demand
with no additional cost



CLD



Dischi adesivi nastro verde 204°C.



Dischi adesivi trasparenti 204 °C.



Green tape peel disks 204 °C.



Clear tape adhesive disks 204 °C.

Ø mm	PCS. ROLL	Ø mm	PCS. ROLL
3	2000	55	250
4	2000	56	250
5	2000	57	250
6	2000	58	250
7	2000	59	250
8	2000	60	250
9	2000	61	250
10	2000	62	250
11	2000	63	250
12	2000	64	250
13	2000	65	250
14	2000	66	250
15	2000	67	250
16	2000	68	250
17	1000	69	250
18	1000	70	250
19	1000	71	250
20	1000	72	250
21	1000	73	250
22	500	74	250
23	500	75	250
24	500	76	250
25	500	77	250
26	500	78	250
27	500	79	250
28	500	80	250
29	500	81	250
30	500	82	250
31	500	83	250
32	500	84	250
33	500	85	250
34	500	86	250
35	500	87	250
36	500	88	250
37	500	89	250
38	500	90	250
39	500	91	250
40	500	92	250
41	500	93	250
42	500	94	250
43	500	95	250
44	500	96	250
45	500	97	250
46	250	98	250
47	250	99	250
48	250	100	250
49	250	150	100
50	250	200	100
51	250	300	100
52	250	400	100
53	250	500	100
54	250		

Ø mm	PCS. ROLL	Ø mm	PCS. ROLL
3	2000	55	250
4	2000	56	250
5	2000	57	250
6	2000	58	250
7	2000	59	250
8	2000	60	250
9	2000	61	250
10	2000	62	250
11	2000	63	250
12	2000	64	250
13	2000	65	250
14	2000	66	250
15	2000	67	250
16	2000	68	250
17	1000	69	250
18	1000	70	250
19	1000	71	250
20	1000	72	250
21	1000	73	250
22	500	74	250
23	500	75	250
24	500	76	250
25	500	77	250
26	500	78	250
27	500	79	250
28	500	80	250
29	500	81	250
30	500	82	250
31	500	83	250
32	500	84	250
33	500	85	250
34	500	86	250
35	500	87	250
36	500	88	250
37	500	89	250
38	500	90	250
39	500	91	250
40	500	92	250
41	500	93	250
42	500	94	250
43	500	95	250
44	500	96	250
45	500	97	250
46	250	98	250
47	250	99	250
48	250	100	250
49	250	150	100
50	250	200	100
51	250	300	100
52	250	400	100
53	250	500	100
54	250		

EUROMASK®

BPC



Altre dimensioni
realizzabili a richiesta
senza costi aggiuntivi
Other sizes on demand
with no additional cost



EBC



Dischi adesivi polimide 260 °C.



Polyimide peel disks 260 °C.

Ø mm	PCS. ROLL	Ø mm	PCS. ROLL
3	2000	55	250
4	2000	56	250
5	2000	57	250
6	2000	58	250
7	2000	59	250
8	2000	60	250
9	2000	61	250
10	2000	62	250
11	2000	63	250
12	2000	64	250
13	2000	65	250
14	2000	66	250
15	2000	67	250
16	2000	68	250
17	1000	69	250
18	1000	70	250
19	1000	71	250
20	1000	72	250
21	1000	73	250
22	500	74	250
23	500	75	250
24	500	76	250
25	500	77	250
26	500	78	250
27	500	79	250
28	500	80	250
29	500	81	250
30	500	82	250
31	500	83	250
32	500	84	250
33	500	85	250
34	500	86	250
35	500	87	250
36	500	88	250
37	500	89	250
38	500	90	250
39	500	91	250
40	500	92	250
41	500	93	250
42	500	94	250
43	500	95	250
44	500	96	250
45	500	97	250
46	250	98	250
47	250	99	250
48	250	100	250
49	250	150	100
50	250	200	100
51	250	300	100
52	250	400	100
53	250	500	100
54	250		



Dischi adesivi in nastro blu 204 °C.



Blue ribbon adhesive disks 204 °C.

Ø mm	PCS. ROLL	Ø mm	PCS. ROLL
3	2000	55	250
4	2000	56	250
5	2000	57	250
6	2000	58	250
7	2000	59	250
8	2000	60	250
9	2000	61	250
10	2000	62	250
11	2000	63	250
12	2000	64	250
13	2000	65	250
14	2000	66	250
15	2000	67	250
16	2000	68	250
17	1000	69	250
18	1000	70	250
19	1000	71	250
20	1000	72	250
21	1000	73	250
22	500	74	250
23	500	75	250
24	500	76	250
25	500	77	250
26	500	78	250
27	500	79	250
28	500	80	250
29	500	81	250
30	500	82	250
31	500	83	250
32	500	84	250
33	500	85	250
34	500	86	250
35	500	87	250
36	500	88	250
37	500	89	250
38	500	90	250
39	500	91	250
40	500	92	250
41	500	93	250
42	500	94	250
43	500	95	250
44	500	96	250
45	500	97	250
46	250	98	250
47	250	99	250
48	250	100	250
49	250	150	100
50	250	200	100
51	250	300	100
52	250	400	100
53	250	500	100
54	250		

WE SOLVE EVERY MASKING PROBLEM

EBV



Altre dimensioni
realizzabili a richiesta
senza costi aggiuntivi
Other sizes on demand
with no additional cost



ELT



Bollini adesivi in vinile 100° C



Vinyl adhesive discs 100 °C.

Ø mm	PCS. ROLL	Ø mm	PCS. ROLL
3	2000	55	250
4	2000	56	250
5	2000	57	250
6	2000	58	250
7	2000	59	250
8	2000	60	250
9	2000	61	250
10	2000	62	250
11	2000	63	250
12	2000	64	250
13	2000	65	250
14	2000	66	250
15	2000	67	250
16	2000	68	250
17	1000	69	250
18	1000	70	250
19	1000	71	250
20	1000	72	250
21	1000	73	250
22	500	74	250
23	500	75	250
24	500	76	250
25	500	77	250
26	500	78	250
27	500	79	250
28	500	80	250
29	500	81	250
30	500	82	250
31	500	83	250
32	500	84	250
33	500	85	250
34	500	86	250
35	500	87	250
36	500	88	250
37	500	89	250
38	500	90	250
39	500	91	250
40	500	92	250
41	500	93	250
42	500	94	250
43	500	95	250
44	500	96	250
45	500	97	250
46	250	98	250
47	250	99	250
48	250	100	250
49	250	150	100
50	250	200	100
51	250	300	100
52	250	400	100
53	250	500	100
54	250		



Bollini adesivi in carta 80 °C.



Semi craped paper discs 80 °C.

Ø mm	PCS. ROLL	Ø mm	PCS. ROLL
3	2000	55	250
4	2000	56	250
5	2000	57	250
6	2000	58	250
7	2000	59	250
8	2000	60	250
9	2000	61	250
10	2000	62	250
11	2000	63	250
12	2000	64	250
13	2000	65	250
14	2000	66	250
15	2000	67	250
16	2000	68	250
17	1000	69	250
18	1000	70	250
19	1000	71	250
20	1000	72	250
21	1000	73	250
22	500	74	250
23	500	75	250
24	500	76	250
25	500	77	250
26	500	78	250
27	500	79	250
28	500	80	250
29	500	81	250
30	500	82	250
31	500	83	250
32	500	84	250
33	500	85	250
34	500	86	250
35	500	87	250
36	500	88	250
37	500	89	250
38	500	90	250
39	500	91	250
40	500	92	250
41	500	93	250
42	500	94	250
43	500	95	250
44	500	96	250
45	500	97	250
46	250	98	250
47	250	99	250
48	250	100	250
49	250	150	100
50	250	200	100
51	250	300	100
52	250	400	100
53	250	500	100
54	250		

Fustellati Speciali

Engineered Die-Cut



Fustellature di precisione.

Produzione di grossi o piccoli volumi.
Vasta gamma di materiali.
Rapidità di approntamento.
Bassi costi di realizzazione impianto.



Engineered precision tape die-cut.

Low or high volume quantities.
Wide variety of materials.
Fast turnaround.
Very reasonable tooling costs.

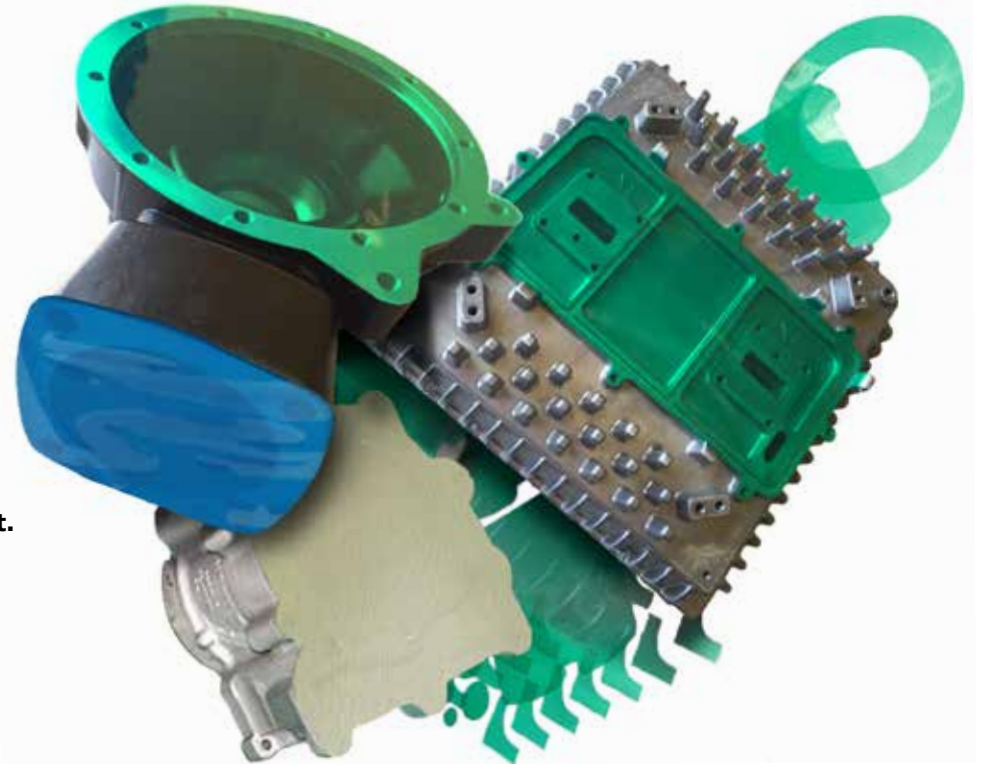

Stampati Speciali

Engineered Molded



Tappi e Cappucci stampati speciali.

Ampia varietà di materiali.
Fornitura di campioni per l'approvazione del cliente prima di avviare la produzione. Nel reparto tecnico di Euromask® lavorano persone esperte; tecnici capaci di disegnare, modellare e realizzare prototipi con velocità e precisione.

Con Euromask®:

- Studio del prototipo da disegno 2D/3D o direttamente dal pezzo.
- Bassissimi costi per la Fornitura dei campioni: tappi o cappucci per la verniciatura ed altri trattamenti superficiali.

Questo in 3 giorni, per geometrie molto complesse 5.

Quando il Cliente approva, immediata messa in produzione. Produciamo in proprio con tecnologie ed impianti moderni ed efficienti. Per i nostri Clienti questo significa costi contenuti e rapidità nella fornitura di grossi e piccoli quantitativi, in una vasta gamma di materiali.



Engineered molded plugs and caps.

Wide variety of materials. Samples always provided for your approval before production. Skilled persons work in Euromask®'s department; technical experts able to draw, model and realize samples with precision and rapidity. With Euromask®:

- Prototype analysis starting from 2D or 3D drawing, or directly from the item that need to be masked
- Low prototypes supply costs: plugs or caps for painting operations and other surface treatments.

This within 3 days, for more complex structures 5 days.

When the customer approves, immediate production. We produce directly on our own with modern and efficient technologies and plants. For our customers this means low prices and fast supply of large and small quantity of goods, with a wide range of materials available.



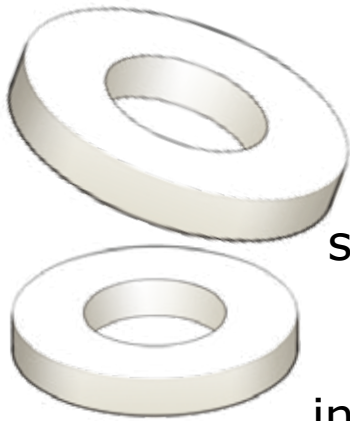

Taglio Piano

Lavorazioni standard e a disegno su lastre da 2 a 15mm di spessore in silicone, EPDM, schiume a varia densità e materiali accoppiati.

Rapidità di campionatura e di produzione in 2/3 giorni in funzione della complessità delle sagome. Le forme realizzate soddisfano sia esigenze di trattamenti a polvere che a liquido creando sagome precise alla richiesta del cliente.

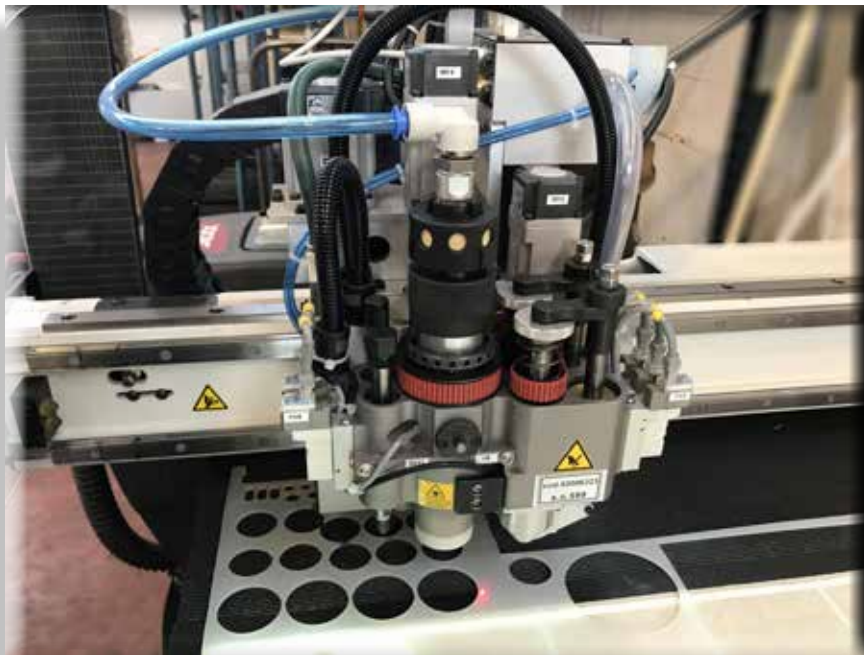

Taglio Piano Speciali

Knife-Cutting Shapes



Knife Cutting

Suitable for standard and bespoke shapes on Silicone, EPDM, Foams and sheets with liner from 2 to 15mm thickness.

Fast sampling and production in 2/3 days, depending on shape. All the materials and shapes created on customer's request are suitable for all the surface treatment, from liquid to powder coatings.

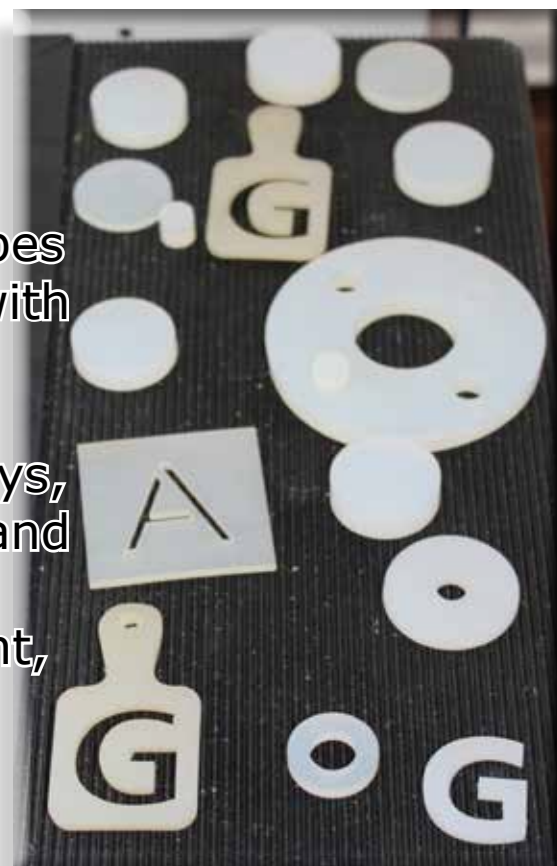

EST



Tubo cavo per rivestimenti in polvere 315 °C.

Indicato per rivestimenti in polvere e rivestimenti elettrostatici per immersione liquida.



Tube for Powder Coating 315 °C.

Recommended for powder coating and E-coating.



CODICE CODE	Ø d	Ø D	LUNGH. LENGTH
EST2	2 mm	4 mm	50 m
EST3	3 mm	5 mm	50 m
EST4	4 mm	6 mm	50 m
EST5	5 mm	7 mm	50 m
EST6	6 mm	8 mm	50 m
EST8	8 mm	10 mm	50 m
EST10	10 mm	12 mm	50 m
EST12	12 mm	15 mm	50 m
EST14	14 mm	16 mm	25 m
EST16	16 mm	22 mm	25 m
EST18	18 mm	22 mm	20 m
EST20	20 mm	24 mm	20 m
EST25	25 mm	33 mm	15 m
EST30	30 mm	40 mm	10 m

ETO



Cordoncino pieno flessibile per rivestimenti in polvere 315 °C.

Indicato per rivestimenti in polvere e rivestimenti elettrostatici per immersione liquida.



Flexible Cord for Powder Coating 315 °C.

Recommended for powder coating and E-coating.

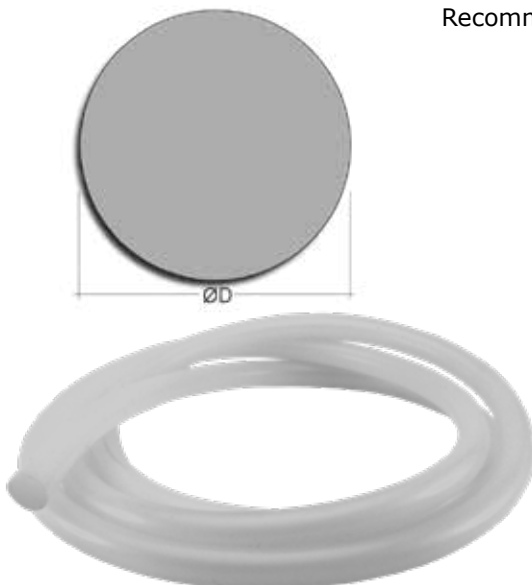

CODICE CODE	Ø D	LUNGH. LENGTH
ETO3	3 mm	100 m
ETO4	4 mm	100 m
ETO5	5 mm	100 m
ETO6	6 mm	50 m
ETO7	7 mm	50 m
ETO8	8 mm	50 m
ETO9	9 mm	25 m
ETO10	10 mm	25 m
ETO11	11 mm	25 m
ETO12	12 mm	25 m
ETO13	13 mm	25 m
ETO14	14 mm	25 m
ETO15	15 mm	25 m
ETO16	16 mm	15 m
ETO18	18 mm	15 m

WE SOLVE EVERY MASKING PROBLEM

EZT

IT

Tubo a stella in silicone 315 °C.

La sua forma permette di utilizzarlo per i vari diametri.

UK

Silicone star tube 315 °C.

Its shape allows to use it for various diameters.

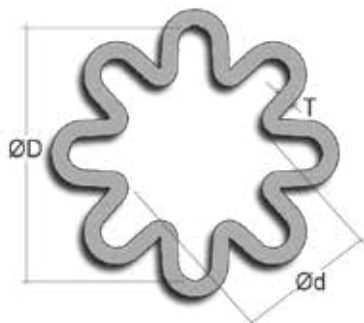

CODICE CODE	Ød	ØD	T
----------------	----	----	---

EZT3X5	2,80	5,30	1,52
--------	------	------	------

EZT5X7	4,80	7,30	1,52
--------	------	------	------

EZT6X6,5	5,08	6,35	1,52
----------	------	------	------

EZT7X9	6,50	9,50	1,52
--------	------	------	------

EZT8X9	7,62	9,53	1,52
--------	------	------	------

EZT9X11	8,50	11,50	1,52
---------	------	-------	------

EZT10X12	10,16	12,70	1,52
----------	-------	-------	------

EZT11X13	10,70	14,00	1,52
----------	-------	-------	------

EZT13X17	12,50	18,00	1,52
----------	-------	-------	------

EZT13X15	12,70	15,88	1,52
----------	-------	-------	------

EZT15X18	15,88	19,05	1,52
----------	-------	-------	------

EZT19X22	18,42	22,23	1,52
----------	-------	-------	------

EZT22X25	21,59	25,40	1,52
----------	-------	-------	------

EZT25X30	25,40	31,75	1,52
----------	-------	-------	------

EZT32X38	31,75	38,10	1,52
----------	-------	-------	------

EZT38X44	38,10	44,45	1,52
----------	-------	-------	------

EZT44X50	44,45	50,80	1,52
----------	-------	-------	------



ASC

IT

Corda in schiuma di silicone tonda 220 °C.

UK

Round silicone foam cord 220 °C.

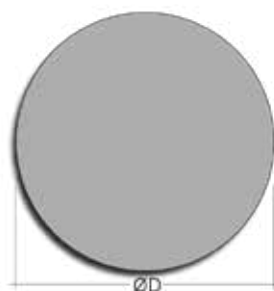

CODICE CODE	DIAM. mm DIAM. mm	LUNGH. LENGTH
----------------	----------------------	------------------

ASC020	2 mm	25 m
--------	------	------

ASC030	3 mm	25 m
--------	------	------

ASC040	4 mm	25 m
--------	------	------

ASC050	5 mm	25 m
--------	------	------

ASC060	6 mm	25 m
--------	------	------

ASC070	7 mm	25 m
--------	------	------

ASC080	8 mm	25 m
--------	------	------

ASC090	9 mm	25 m
--------	------	------

ASC100	10 mm	25 m
--------	-------	------

ASC120	12 mm	25 m
--------	-------	------

ASC160	16 mm	25 m
--------	-------	------

ASC180	18 mm	25 m
--------	-------	------

ASC200	20 mm	25 m
--------	-------	------

ASC250	25 mm	25 m
--------	-------	------

ASC300	30 mm	25 m
--------	-------	------



QSC

IT

Corda in schiuma di silicone quadra 220 °C.

UK

Square silicone foam cord 220 °C.



CODICE CODE	SEZIONE	LUNGH. LENGTH
----------------	---------	------------------

QSC 10 X 10	10 mm	25 m
-------------	-------	------

QSC 12 X 12	12 mm	25 m
-------------	-------	------

QSC 20 X 20	20 mm	25 m
-------------	-------	------



TMF



Tappi multi-flangia in Silicone per fori di diversi diametri.



Silicone multi-flange plugs suitable for different diameters

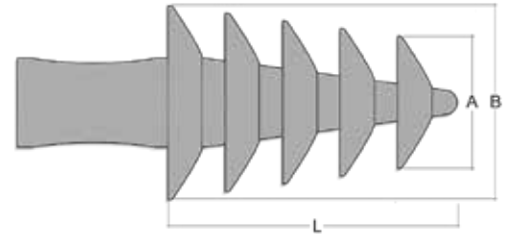

CODICE CODE	A	B	L	PZ CONF. PCS. BOX
TMF4-10	4,00	10,00	13,60	500
TMF8-16	8,00	16,00	23,50	200
TMF10-18	10,00	18,00	24,00	200

FORME E DIMENSIONI PERSONALIZZATE REALIZZABILI SU RICHIESTA

DFPP

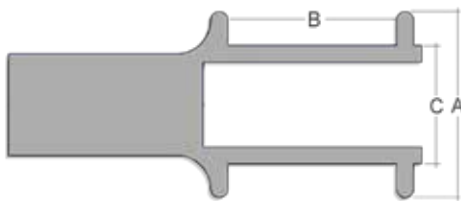

Tappo speciale per protezione dadi 315 °C



Special nut protection plug 315 °C

CODICE CODE	A	B	C	PZ CONF. PCS. BOX
DFPP05	5,40	3,00	4,10	500
DFPP06	6,70	3,80	5,10	500
DFPP08	8,70	5,35	6,70	500
DFPP10	11,20	6,60	8,50	500
DFPP12	13,00	6,60	10,10	250
DFPP14	15,20	8,00	12,10	250
DFPP16	16,60	9,30	13,90	100
DFPP18	19,80	10,50	15,90	100
DFPP20	21,01	12,30	17,80	100

FORME E DIMENSIONI PERSONALIZZATE REALIZZABILI SU RICHIESTA

CSINK



Tappo speciale con flangia 315 °C



Countersink plugs 315 °C

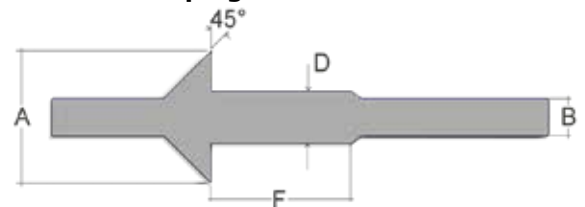

CODICE CODE	A	B	D	F	PZ. CONF. PCS. BOX
CSINK030	10,00	2,50	2,90	15,00	100
CSINK040	10,00	3,00	3,80	15,00	100
CSINK045	12,00	3,00	4,50	15,00	100
CSINK050	15,00	4,00	5,00	15,00	100
CSINK060	14,00	4,00	5,50	15,00	100
CSINK080	16,00	4,00	7,40	15,00	100
CSINK100	18,00	5,00	9,20	15,00	100
CSINK120	20,00	5,00	11,00	15,00	100
CSINK140	20,00	6,00	13,46	15,00	100

FORME E DIMENSIONI PERSONALIZZATE REALIZZABILI SU RICHIESTA

WE SOLVE EVERY MASKING PROBLEM



Tappi conici con maniglia 315 °C.

Indicato per rivestimenti in polvere, elettrostatici per immersione liquida e platinatura. Riutilizzabili.



Silicone conical plugs with handle 315 °C.

Recommended for powder coating, E-coating and plating. Reusable.

CPHS

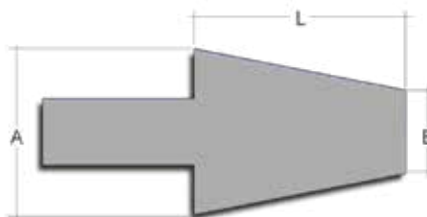

CODICE CODE	FORI HOLES	A	B	L	PZ BOX PCS BOX
CPHS100	1-3	3,18	1,60	15,88	1000
CPHS101	2-4	4,75	1,60	15,88	1000
CPHS102	4-6	6,35	3,18	19,05	1000
CPHS103	6-8	8,71	4,78	15,88	1000
CPHS104	7-9	9,53	6,35	19,05	100
CPHS000	9-10	11,91	8,74	20,65	100
CPHS00	11-14	15,09	10,31	25,40	100
CPHS0	14-16	16,66	12,70	25,40	100

FORME E DIMENSIONI PERSONALIZZATE REALIZZABILI SU RICHIESTA



Tappi copri-filetto 315 °C.



Thread mask 315 °C.



ETM

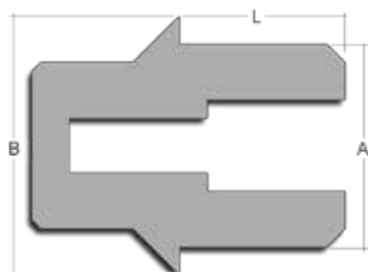

CODICE CODE	A	B	L	PZ CONF. PCS. BOX
ETM6	5,33	6,35	5,08	500
ETM8	7,20	8,55	3,20	500
ETM10	9,00	10,15	4,70	250
ETM12	11,00	12,20	6,70	250
ETM16	14,90	16,60	8,30	100
ETM20	18,40	20,50	10,30	100

FORME E DIMENSIONI PERSONALIZZATE REALIZZABILI SU RICHIESTA



Tappo conico cavo con maniglia 315 °C.



Hollow conical plug with handle 315 °C.

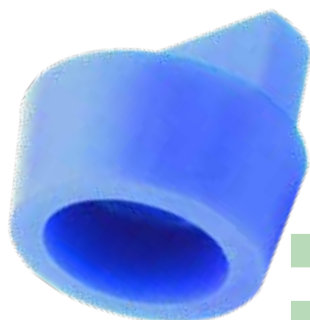

MHEP

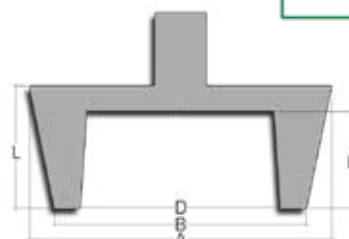

CODICE CODE	A	B	L	D	E	PZ CONF. PCS. BOX
MHEP5	27,00	23,01	25,40	10,31	19,05	100
MHEP6	31,75	26,19	25,40	13,49	19,05	100
MHEP7	36,50	30,15	25,40	17,45	19,05	10
MHEP10	50,01	41,28	25,40	28,58	19,05	10
MHEP11	55,96	47,63	25,40	34,93	19,05	1

FORME E DIMENSIONI PERSONALIZZATE REALIZZABILI SU RICHIESTA

info@euromask-shop.com

WFP



Tappi con rondella 315 °C.

Ideale per mascherare attorno ad un foro per la messa a terra. Duplice possibilità d'uso.



Silicone Flange Plugs 315 °C.

Ideal for masking holes and the grounding area around them. Dual purpose plugs.

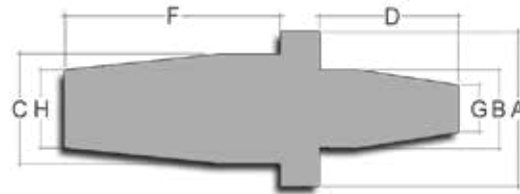

CODICE CODE	FORO HOLE	A	B	C	D	F	G	H	PZ CONF. PCS BOX
WFP110-276-146	M3	7,00	2,80	3,70	5,80	7,40	1,40	1,90	1000
WFP142-354-195	M4	9,00	3,60	4,70	7,20	9,40	1,80	2,40	1000
WFP177-394-224	M5	9,50	4,50	5,70	9,00	11,40	2,30	2,80	1000
WFP289-492-264	M6	12,50	5,30	6,70	10,60	13,40	2,60	3,40	500
WFP280-669-343	M8	17,00	7,10	8,70	14,20	17,40	3,60	4,30	500
WFP378-827-421	M10	21,00	9,60	10,70	19,20	21,40	4,80	5,40	250
WFP429-945-500	M12	24,00	10,90	12,70	21,80	25,40	5,50	6,40	250

FORME E DIMENSIONI PERSONALIZZATE REALIZZABILI SU RICHIESTA

SP



Tappi a gradino 315 °C.

Indicati per rivestimenti in polvere, elettrostatici per immersione liquida, anodizzazione e platinatura. Assicura una zona pulita attorno al diametro del foro per la messa a terra.



Step Plugs 315 °C.

Recommended for powder coating, E-coating, anodizing and plating.

Provides clean area around diameter of hole for earthing purpose.

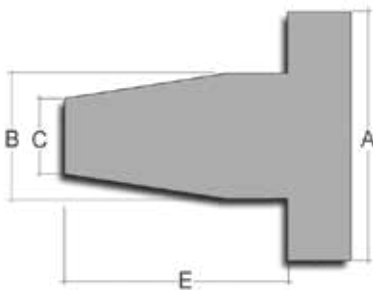

CODICE CODE	A	B	C	E	PZ CONF. PCS BOX
SP03	7,01	3,00	2,36	13,00	500
SP04	8,00	5,00	2,84	14,00	500
SP05	8,99	5,99	3,94	16,03	500
SP06	10,16	6,43	4,78	17,63	250
SP08	12,42	8,23	5,94	17,32	250

FORME E DIMENSIONI PERSONALIZZATE REALIZZABILI SU RICHIESTA

SKIT



Starter kit.



CODICE CODE

ARTICOLO ITEMS

SKITSILI Starter kit tappi e cappucci in silicone 315 °C

SKITEPDM Starter kit tappi e cappucci in E.P.D.M 177 °C

WE SOLVE EVERY MASKING PROBLEM



Tappi senza flange 315 ° C.

Indicati per rivestimenti in polvere, elettrostatici per immersione liquida, platinatura e anodizzazione.

Fori filettati. Forma conica e interno cavo per molteplici applicazioni.

Proteggono i fori filettati senza mascherare la zona circostante.



Flangeless Plugs 315 °C.

Recommended for powder coating, E-coating, plating and anodizing. Threaded holes.

Tapered design and hollow core for multi-applications.

Protect threaded holes without masking the surrounding area.

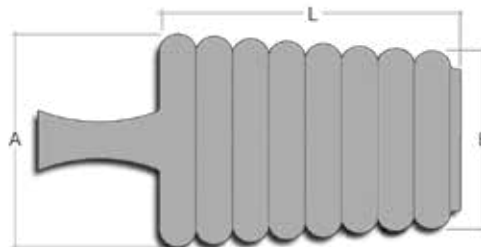

CODICE CODE	A	B	L	PZ. CONF. PCS. BOX
FP157	3,99	2,01	19,05	250
FP250	5,99	3,99	25,40	250
FP312	8,00	5,99	25,40	250
FP394	10,01	8,00	25,40	250
FP406	10,31	7,95	25,40	250
FP468	11,89	10,31	25,40	250
FP472	11,99	10,01	25,40	250
FP551	14,00	11,99	25,40	250
FP562	14,27	11,89	25,40	250
FP625	15,88	14,27	25,40	250
FP630	16,00	14,00	25,40	250
FP709	18,01	16,00	25,40	250
FP718	18,24	15,88	25,40	250
FP750	19,05	18,24	25,40	100
FP787	19,99	18,01	25,40	100
FP866	22,23	19,05	25,40	100
FP886	22,50	19,99	25,40	100
FP945	24,00	22,50	25,40	100
FP1000	25,40	22,23	25,40	100
FP1024	26,01	24,00	25,40	100
FP1102	27,99	26,01	25,40	100
FP1125	28,58	25,40	25,40	100
FP1250	31,75	28,58	25,40	100



FORME E DIMENSIONI PERSONALIZZATE REALIZZABILI SU RICHIESTA

info@euromask-shop.com

HEP

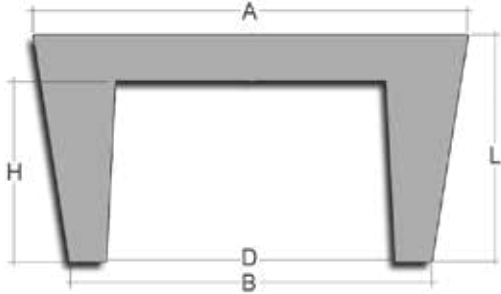

Tappi conici in silicone concavi 315 °C.

Indicato per rivestimenti in polvere, elettrostatici per immersione liquida e platinatura. Riutilizzabili.



Hollow silicone plugs 315 °C.

Recommended for powder coating, E-coating and plating. Reusable.

CODICE CODE	A	B	L	D	H	PZ CONF. PCS BOX
HEP5	27,00	23,01	25,40	12,50	19,05	100
HEP5,5	27,94	24,00	25,40	13,00	19,05	100
HEP6	32,00	26,19	25,40	15,50	19,05	100
HEP6,5	33,99	27,00	25,40	17,00	19,05	100
HEP7	36,53	30,18	25,40	17,48	19,05	10
HEP7,5	38,99	30,99	25,40	21,80	19,05	10
HEP8	41,28	33,35	25,40	20,65	19,05	10
HEP8,5	43,00	35,99	25,40	26,00	19,05	10
HEP9	44,45	37,31	25,40	24,61	19,05	10
HEP9,5	45,97	38,00	25,40	25,30	19,05	10
HEP10	49,99	41,99	25,40	31,60	19,05	10
HEP10,5	52,98	44,96	25,40	32,26	19,05	10
HEP11	55,96	48,01	25,40	35,31	19,05	1
HEP11,5	62,71	50,01	25,40	30,96	15,88	1
HEP12	63,50	53,98	25,40	34,93	15,88	1
HEP13	68,28	57,94	25,40	38,89	15,88	1
HEP13,5	75,01	61,93	34,93	42,88	25,40	1
HEP13,78	81,99	68,00	38,10	42,60	25,40	1
HEP14	88,90	76,20	38,10	50,80	25,40	1
HEP15	101,60	82,55	38,10	57,15	25,40	1
HEP16	127,00	88,90	50,80	78,00	30,00	1



FORME E DIMENSIONI PERSONALIZZATE REALIZZABILI SU RICHIESTA

WE SOLVE EVERY MASKING PROBLEM

CPP



Tappi con maniglia di estrazione 315 °C

Per rivestimenti in polvere, elettrostatici per immersione liquida, anodizzazione e platinatura. Ideali per fori passanti.



Pull Plug 315 °C

Recommended for powder coating, E-coating, anodizing and plating. Ideal for through holes.

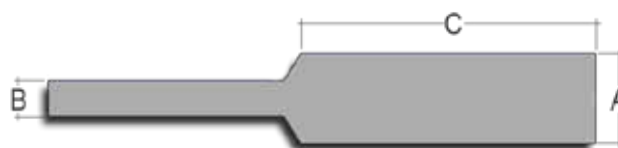

	CODICE CODE	A	B	C	PCS BOX
	CPP06	1,57	1,02	12,70	500
	CPP07	1,70	1,19	15,88	500
	CPP08	1,85	1,17	15,54	500
	CPP09	2,31	1,32	15,88	500
	CPP10(2)	2,36	1,27	15,88	500
	CPP95-1000	2,41	1,32	25,40	500
	CPP10(A)	2,67	2,08	25,40	500
	CPP11	2,77	1,57	25,40	500
	CPP11B	3,00	2,08	25,40	500
	CPP11A(3)	3,18	1,57	15,88	500
	CPP15	3,30	2,36	15,88	500
	CPP14	3,30	2,36	25,40	500
	CPP17	3,56	2,16	15,88	500
	CPP18	3,91	1,57	15,88	500
	CPP20(4A)	3,96	1,57	15,88	500
	CPP21	4,01	2,08	31,75	500
	CPP22	4,11	2,44	15,88	500
	CPP23(4)	4,95	2,79	25,40	500
	CPP26	5,00	2,79	25,40	500
	CPP30	5,54	3,30	25,40	500
	CPP33	5,72	3,18	25,40	500
	CPP37(5)	6,53	3,30	25,40	500
	CPP40	6,99	3,18	23,80	500
	CPP42(6)	7,92	3,73	25,40	500

	CODICE CODE	A	B	C	PCS BOX
	CPP42	8,43	6,35	28,58	500
	CPP43	8,51	3,89	25,40	500
	CPP355-1000	9,02	3,99	25,40	500
	CPP50	9,53	3,99	25,40	500
	CPP55	9,75	3,91	25,40	250
	CPP55(7)	9,86	3,99	25,40	250
	CPP60	10,36	4,85	25,63	250
	CPP63	10,52	3,99	13,34	250
	CPP66	11,28	6,48	25,40	250
	CPP67	11,30	6,48	25,40	250
	CPP70	11,89	6,35	25,40	250
	CPP73	12,60	6,35	25,40	250
	CPP77	12,95	6,50	25,40	250
	CPP80	13,46	6,35	25,40	250
	CPP570-1000	14,48	7,92	25,40	100
	CPP87	15,54	6,35	25,40	100
	CPP88	15,75	8,36	38,10	100
	CPP90	16,26	9,53	25,40	100
	CPP95	17,78	9,53	31,75	100
	CPP100	19,56	9,53	25,40	100
	CPP809-1000	20,55	8,00	25,40	50
	CPP110(13)	22,76	9,53	25,40	50
	CPP120	25,91	9,53	25,40	50
	CPP130	35,05	12,70	25,40	50



FORME E DIMENSIONI PERSONALIZZATE REALIZZABILI SU RICHIESTA

EPP

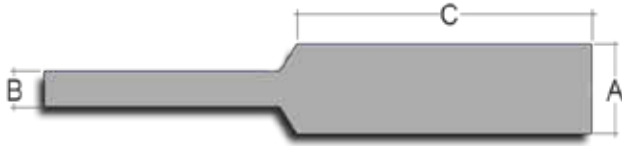

Tappi con maniglia di estrazione E.P.D.M. 177 °C
Indicati per verniciatura a liquido, platinatura, anodizzazione e sabbatura. Ideali per fori passanti.



E.P.D.M. Pull Plug 177 °C
Recommended for painting, plating, anodizing and blasting. Ideal for through holes.

CODICE CODE	A	B	C	PCS BOX
EPP06	1,57	1,02	12,70	500
EPP07	1,70	1,19	15,88	500
EPP08(1)	1,85	1,17	15,54	500
EPP09	2,31	1,32	15,88	500
EPP10(2)	2,36	1,27	15,88	500
EPP95-1000	2,41	1,32	25,40	500
EPP10A	2,67	2,08	25,40	500
EPP11	2,77	1,57	25,40	500
EPP11B	3,00	2,08	25,40	500
EPP11A(3)	3,18	1,57	15,88	500
EPP15	3,30	2,36	15,88	500
EPP14	3,30	2,36	25,40	500
EPP17	3,56	2,16	15,88	500
EPP18	3,91	1,57	15,88	500
EPP20(4A)	3,96	1,57	15,88	500
EPP21	4,01	2,08	31,75	500
EPP22	4,11	2,44	15,88	500
EPP23(4)	4,95	2,79	25,40	500
EPP26	5,00	2,79	25,40	500
EPP30	5,54	3,30	25,40	500
EPP33	5,72	3,18	25,40	500
EPP37(5)	6,53	3,30	25,40	500
EPP40	6,99	3,18	23,80	500
EPP42(6)	7,92	3,73	25,40	500

CODICE CODE	A	B	C	PCS BOX
EPP42A	8,43	6,35	28,58	500
EPP43	8,51	3,89	25,40	500
EPP50	9,53	3,99	25,40	500
EPP55(7)	9,86	3,99	25,40	250
EPP400-1000	10,16	3,99	24,40	250
EPP60	10,36	4,85	25,63	250
EPP63	10,52	3,99	13,34	250
EPP66(8)	11,28	6,48	25,40	250
EPP67(8)	11,30	6,48	25,40	250
EPP70	11,89	6,35	25,40	250
EPP73(9)	12,60	6,35	25,40	250
EPP77	12,95	6,50	25,40	250
EPP80(10)	13,46	6,35	25,40	250
EPP87	15,54	6,35	25,40	100
EPP88	15,75	8,36	38,10	100
EPP90(11)	16,26	9,53	25,40	100
EPP95	17,78	9,53	31,75	100
EPP100(12)	19,56	9,53	25,40	100
EPP110(13)	22,76	9,53	25,40	50
EPP120(14)	25,91	9,53	25,40	50
EPP130	35,05	12,70	25,40	50



WE SOLVE EVERY MASKING PROBLEM



Tappi Conici 315 °C.

Indicato per rivestimenti in polvere, elettrostatici per immersione liquida e platinatura. Riutilizzabili.



Conical Plugs 315 °C.

Recommended for powder coating, E-coating and plating. Reusable.

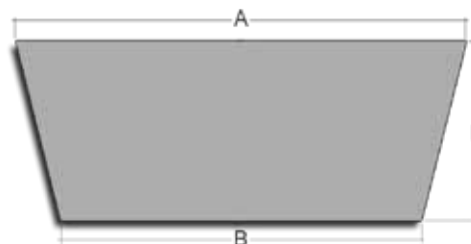

	CODICE CODE	A	B	L	PCS BOX
	EP63	1,60	0,41	15,88	1000
	EP78	1,98	0,51	19,05	1000
	EP81	2,54	0,81	15,88	1000
	EP99	3,18	0,79	15,88	1000
	EP100	3,18	1,60	15,88	1000
	EP101SH	4,75	2,79	10,01	1000
	EP101	4,75	1,60	15,88	1000
	EP101XL	4,75	1,60	19,05	1000
	EP101SXL	4,75	1,60	25,40	1000
	EP102	6,35	3,18	19,05	1000
	EP102XL	6,35	3,18	25,40	1000
	EP103	8,71	4,78	15,88	1000
	EP103XL	8,71	4,78	25,40	1000
	EP105	9,53	6,35	12,70	100
	EP104	9,53	6,35	19,05	100
	EP375XL	9,53	3,18	31,75	100
	EP394XL	10,01	5,00	48,01	100
	EP104XL	11,10	6,35	25,40	100
	EP106	11,13	8,74	17,48	100
	EP000	11,91	8,74	20,65	100
	EP000XL	12,70	7,90	25,40	100
	EP500XL	12,70	3,20	50,80	100
	EP107	14,30	7,95	25,40	100
	EP107XL	15,01	3,00	35,00	100
	EP00	15,09	10,31	25,40	100
	EP108	15,88	11,13	22,23	100
	EPO	16,66	12,70	25,40	100
	EP109	17,45	11,13	25,40	100

	CODICE CODE	A	B	L	PCS BOX
	EP1	19,00	14,27	25,40	100
	EP2	19,99	15,88	25,40	100
	EP2,5	20,62	15,88	25,40	100
	EP3	23,83	18,26	25,40	100
	EP3,5	25,00	17,00	25,40	100
	EP4	25,40	19,84	25,40	100
	EP4,5	26,01	19,99	25,40	100
	EP5	27,00	23,01	25,40	100
	EP5,5	27,94	23,83	25,40	100
	EP6	31,75	26,19	25,40	100
	EP6,5	33,35	27,00	25,40	100
	EP7	36,53	30,18	25,40	10
	EP7,5	38,89	31,75	25,40	10
	EP8	41,28	33,35	25,40	10
	EP8,5	42,88	35,71	25,40	10
	EP9	44,45	37,31	25,40	10
	EP9,5	46,05	38,10	25,40	10
	EP10	50,01	41,28	25,40	10
	EP10,5	52,40	44,45	25,40	10
	EP11	55,96	47,63	25,40	1
	EP11,5	62,71	50,01	25,40	1
	EP12	63,50	53,98	25,40	1
	EP13	68,28	57,94	25,40	1
	EP13,5	75,01	61,93	34,93	1
	EP13,78	82,00	68,00	35,00	1
	EP14	88,90	76,20	38,10	1
	EP15	101,60	82,55	38,10	1
	EP16	127,00	88,90	50,80	1



FORME E DIMENSIONI PERSONALIZZATE REALIZZABILI SU RICHIESTA

BP

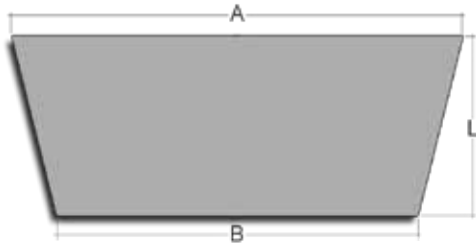

CODICE CODE	A	B	L	PCS BOX
BP63	1,60	0,41	15,88	1000
BP78	1,98	0,51	19,05	1000
BP81	2,54	0,81	15,88	1000
BP99	3,18	0,79	15,88	1000
BP100	3,18	1,60	15,88	1000
BP101SH	4,75	2,79	10,01	1000
BP101	4,75	1,60	15,88	1000
BP101XL	4,75	1,60	19,05	1000
BP101SXL	4,75	1,60	25,40	1000
BP102	6,35	3,18	19,05	1000
BP102XL	6,35	3,18	25,40	1000
BP103	8,71	4,78	15,88	1000
BP103XL	8,71	4,78	25,40	1000
BP105	9,53	6,35	12,70	100
BP104	9,53	6,35	19,05	100
BP375XL	9,53	3,18	31,75	100
BP394XL	10,01	5,00	48,01	100
BP104XL	11,10	6,35	25,40	100
BP106	11,13	8,74	17,48	100
BP000	11,91	8,74	20,65	100
BP000XL	12,70	7,90	25,40	100
BP500XL	12,70	3,20	50,80	100
BP107	14,30	7,95	25,40	100
BP107XL	15,01	3,00	35,00	100
BP00	15,09	10,31	25,40	100
BP108	15,88	11,13	22,23	100
BPO	16,66	12,70	25,40	100
BP109	17,45	11,13	25,40	100



Tappi Conici neri in E.P.D.M. 177 °C.

Indicati per verniciatura a liquido, platinatura, anodizzazione e sabbiatura.



Black E.P.D.M. Conical Plugs 177 °C.

Recommended for painting, plating, anodizing and blasting.

CODICE CODE	A	B	L	PCS BOX
BP1	19,00	14,27	25,40	100
BP2	19,99	15,88	25,40	100
BP2,5	20,62	15,88	25,40	100
BP3	23,83	18,26	25,40	100
BP3,5	25,00	17,00	25,40	100
BP4	25,40	19,84	25,40	100
BP4,5	26,01	19,99	25,40	100
BP5	27,00	23,01	25,40	100
BP5,5	27,94	23,83	25,40	100
BP6	31,75	26,19	25,40	100
BP6,5	33,35	27,00	25,40	100
BP7	36,53	30,18	25,40	100
BP7,5	38,89	31,75	25,40	50
BP8	41,28	33,35	25,40	50
BP8,5	42,88	35,71	25,40	50
BP9	44,45	37,31	25,40	50
BP9,5	46,05	38,10	25,40	50
BP10	50,01	41,28	25,40	50
BP10,5	52,40	44,45	25,40	50
BP11	55,96	47,63	25,40	1
BP11,5	62,71	50,01	25,40	1
BP12	63,50	53,98	25,40	1
BP13	68,28	57,94	25,40	1
BP13,5	75,01	61,93	34,93	1
BP13,78	68,00	82,00	35,00	1
BP14	88,90	76,20	38,10	1
BP15	101,60	82,55	38,10	1
BP16	127,00	88,90	50,80	1



FORME E DIMENSIONI PERSONALIZZATE REALIZZABILI SU RICHIESTA









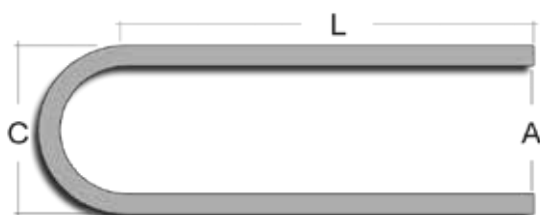

















WE SOLVE EVERY MASKING PROBLEM































 **Rivestimenti in polvere Cappucci 315 °C.**

 **Powder Coating Caps 315 °C.**

EC































	CODICE CODE	A	C	L	PCS BOX
	EC20	0,51	3,55	12,70	1000
	EC35	0,89	3,43	12,70	1000
	EC40-500	1,02	3,32	12,70	1000
	EC40-750	1,02	3,30	19,05	1000
	EC62-750	1,57	3,80	19,05	1000
	EC70	1,78	4,08	25,40	1000
	EC80-750	2,03	5,07	19,05	1000
	EC93-500	2,36	4,95	12,70	1000
	EC93-750	2,36	4,95	19,05	1000
	EC100-500	2,54	5,13	12,70	1000
	EC100-750	2,54	5,13	19,05	1000
	EC100	2,54	5,13	25,40	1000
	EC100-1500	2,54	5,58	38,10	1000
	EC109-500	2,77	5,81	12,70	1000
	EC109	2,77	5,36	19,05	1000
	EC125-500	3,18	5,77	12,70	1000
	EC125-750	3,18	6,22	19,05	1000
	EC125	3,18	5,77	25,40	1000
	EC125-1500	3,18	6,22	38,10	1000
	EC137-1000	3,48	6,52	25,40	1000
	EC140-500	3,56	6,60	12,70	1000
	EC140	3,56	6,60	25,40	1000
	EC148-500	3,76	6,80	12,70	1000
	EC148-750	3,76	6,80	19,05	1000
	EC148	3,76	6,80	25,40	1000
	EC148-1500	3,76	6,80	38,10	1000
	EC156-500	3,96	7,00	12,70	1000
	EC156	3,96	7,00	25,40	1000
	EC165-1000	4,19	7,23	25,40	1000
	EC172-500	4,37	7,41	12,70	1000
	EC172	4,37	7,41	25,40	1000































	CODICE CODE	A	C	L	PCS BOX
	EC172-1500	4,37	7,41	38,10	1000
	EC180	4,57	7,61	25,40	1000
	EC187-500	4,75	7,79	12,70	1000
	EC187-750	4,75	7,79	19,05	1000
	EC187	4,75	7,79	25,40	1000
	EC187-1500	4,75	7,79	38,10	1000
	EC197-500	5,00	8,04	12,70	500
	EC218	5,54	8,58	25,40	500
	EC223-500	5,66	8,70	12,70	500
	EC223-750	5,66	8,70	19,05	500
	EC223-1000	5,66	8,70	25,40	500
	EC223	5,66	8,70	38,10	500
	EC234-500	5,94	8,98	12,70	500
	EC234-750	5,94	8,98	20,00	500
	EC234	5,94	8,98	25,40	500
	EC234-1500	5,94	8,98	38,10	500
	EC250-500	6,35	9,39	12,70	500
	EC250	6,35	9,39	25,40	500
	EC260	6,60	9,64	25,40	500
	EC281	7,14	10,18	25,40	500
	EC281-2000	7,14	10,18	50,80	500
	EC295-500	7,49	10,53	12,70	500
	EC295-750	7,49	10,53	19,05	500
	EC295-1000	7,49	10,53	25,40	500
	EC295	7,49	10,53	38,10	500
	EC295-2350	7,49	10,53	59,00	500
	EC312	7,92	10,96	25,40	500
	EC312-1500	7,92	10,96	38,10	500
	EC340	8,64	11,68	25,40	500
	EC355	9,02	12,06	38,10	500



FORME E DIMENSIONI PERSONALIZZATE REALIZZABILI SU RICHIESTA



	CODICE CODE	A	C	L	PCS BOX
	EC375-750	9,53	12,57	19,05	500
	EC375	9,53	12,57	25,40	500
	EC375-1500	9,53	12,57	38,10	500
	EC375-1969	9,53	12,57	50,01	500
	EC406	10,31	13,35	25,40	500
	EC406-1500	10,31	13,35	38,10	500
	EC437	11,10	14,14	25,40	500
	EC437-2000	11,10	14,14	50,80	500
	EC456-500	11,58	14,62	12,70	500
	EC456-750	11,58	14,62	19,05	500
	EC456-1000	11,58	14,62	25,40	500
	EC456	11,58	14,62	38,10	500
	EC456-1969	11,58	14,62	50,01	500
	EC468	11,89	14,93	25,40	500
	EC468-1500	11,89	14,93	38,10	500
	EC480-1000	12,19	15,23	25,40	500
	EC480	12,19	15,23	38,10	500
	EC500-750	12,70	15,74	19,05	500
	EC500	12,70	15,74	38,10	500
	EC535-750	13,59	16,63	19,05	250
	EC535	13,59	16,63	38,10	250
	EC535-3000	13,59	16,63	76,20	250
	EC562-659	14,27	17,31	16,74	250
	EC562	14,27	17,31	38,10	250
	EC600	15,24	18,28	38,10	250
	EC625-750	15,88	18,92	19,05	250
	EC625-1125	15,88	18,92	28,58	250
	EC625-1250	15,88	18,92	31,75	250
	EC625	15,88	18,92	38,10	250
	EC625-2500	15,88	18,92	63,50	250

	CODICE CODE	A	C	L	PCS BOX
	EC687	17,45	20,49	38,10	250
	EC687-2500	17,45	20,49	63,50	250
	EC730	18,54	21,58	38,10	250
	EC750	19,05	22,09	38,10	250
	EC750-2000	19,05	22,09	50,80	250
	EC750-3500	19,05	22,09	88,90	250
	EC780	19,81	22,85	38,10	250
	EC812	20,62	23,66	38,10	250
	EC845-2844	21,46	24,50	72,24	250
	EC875-1000	22,23	25,27	25,40	250
	EC875	22,23	25,27	38,10	250
	EC937	23,80	26,84	38,10	250
	EC970	24,64	27,68	38,10	250
	EC1000	25,40	28,44	38,10	250
	EC1000-2000	25,40	28,44	50,80	250
	EC1062	26,97	30,01	38,10	100
	EC1062-2000	26,97	30,01	50,80	100
	EC1125	28,58	31,62	38,10	100
	EC1187	30,15	33,19	38,10	100
	EC1250	31,75	34,79	38,10	100
	EC1350	34,29	37,33	38,10	100
	EC1380	35,05	38,09	38,10	100
	EC1500	38,10	41,14	25,40	100
	EC1500-1500	38,10	41,14	38,10	100
	EC1500-1750	38,10	41,14	44,45	50
	EC1625	41,28	44,32	50,80	50
	EC1750	44,45	47,49	50,80	50
	EC1875	47,63	50,67	50,80	50
	EC2000	50,80	53,84	50,80	50
	EC2105	53,47	56,51	50,80	50



FORME E DIMENSIONI PERSONALIZZATE REALIZZABILI SU RICHIESTA

WE SOLVE EVERY MASKING PROBLEM



Cappucci in E.P.D.M. 177 °C.

Indicati per verniciatura a liquido, platinatura, anodizzazione. Riutilizzabili.



E.P.D.M. Caps 177 °C.

Recommended for painting, plating and anodizing. Reusable.



CODICE CODE	A	C	L	PCS BOX
EE20-500	0,51	3,55	12,70	1000
EE35-500	0,89	3,43	12,70	1000
EE40-500	1,02	3,32	12,70	1000
EE40-750	1,02	3,30	19,05	1000
EE62-750	1,57	4,61	19,05	1000
EE70-1000	1,78	4,08	25,40	1000
EE80-750	2,03	5,07	19,05	1000
EE93-500	2,36	4,95	12,70	1000
EE93-750	2,36	4,95	19,05	1000
EE93-1000	2,36	5,40	25,40	1000
EE100-500	2,54	5,13	12,70	1000
EE100-1000	2,54	5,13	25,40	1000
EE100-1500	2,54	5,58	38,10	1000
EE109-500	2,77	5,81	12,70	1000
EE109-750	2,77	5,36	19,05	1000
EE125-500	3,18	5,77	12,70	1000
EE125-750	3,18	6,22	19,05	1000
EE125-1000	3,18	5,77	25,40	1000
EE125-1500	3,18	6,22	38,10	1000
EE137-1000	3,48	6,52	25,40	1000
EE140-500	3,56	6,60	12,70	1000
EE140-1000	3,56	6,60	25,40	1000
EE148-500	3,76	6,80	12,70	1000
EE148-750	3,76	6,80	19,05	1000
EE148-1000	3,76	6,80	25,40	1000
EE148-1500	3,76	6,80	38,10	1000
EE156-500	3,96	7,00	12,70	1000
EE156-1000	3,96	7,00	25,40	1000
EE165-1000	4,19	7,23	25,40	1000
EE172-500	4,37	7,41	12,70	1000

CODICE CODE	A	C	L	PCS BOX
EE172-1000	4,37	7,41	25,40	1000
EE172-1500	4,37	7,41	38,10	1000
EE180-1000	4,57	7,61	25,40	1000
EE187-500	4,75	7,79	12,70	1000
EE187-750	4,75	7,79	19,05	1000
EE187-1000	4,75	7,79	25,40	1000
EE187-1500	4,75	7,79	38,10	1000
EE197-500	5,00	8,04	12,70	500
EE218-1000	5,54	8,58	25,40	500
EE223-500	5,66	8,70	12,70	500
EE223-750	5,66	8,70	19,05	500
EE223-1000	5,66	8,70	25,40	500
EE223-1500	5,66	8,70	38,10	500
EE234-500	5,94	8,98	12,70	500
EE234-787	5,94	8,98	19,99	500
EE234-1000	5,94	8,98	25,40	500
EE234-1500	5,94	8,98	38,10	500
EE250-500	6,35	9,39	12,70	500
EE250-1000	6,35	9,39	25,40	500
EE260-1000	6,60	9,64	25,40	500
EE281-1000	7,14	10,18	25,40	500
EE281-2000	7,14	10,18	50,80	500
EE295-500	7,49	10,53	12,70	500
EE295-750	7,49	10,53	19,05	500
EE295-1000	7,49	10,53	25,40	500
EE295-1500	7,49	10,53	38,10	500
EE295-2350	7,49	10,53	60,00	500
EE312-1000	7,92	10,96	25,40	500
EE312-1500	7,92	10,96	38,10	500
EE340-1000	8,64	11,68	25,40	500

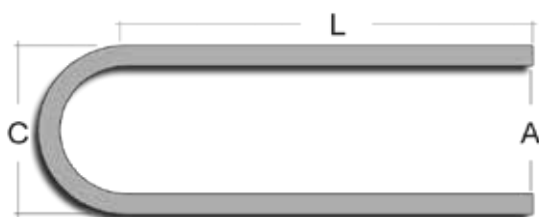

FORME E DIMENSIONI PERSONALIZZATE REALIZZABILI SU RICHIESTA

EE

CODICE CODE	A	C	L	PCS BOX
EE355-1500	9,02	12,06	38,10	500
EE375-750	9,53	12,57	19,05	500
EE375-1000	9,53	12,57	25,40	500
EE375-1500	9,53	12,57	38,10	500
EE375-1969	9,53	12,57	50,01	500
EE406-1000	10,31	13,35	25,40	500
EE406-1500	10,31	13,35	38,10	500
EE437-1000	11,10	14,14	25,40	500
EE437-2000	11,10	14,14	50,80	500
EE456-500	11,58	14,62	12,70	500
EE456-750	11,58	14,62	19,05	500
EE456-1000	11,58	14,62	25,40	500
EE456-1500	11,58	14,62	38,10	500
EE456-1969	11,58	14,62	50,01	500
EE468-1000	11,89	14,93	25,40	500
EE468-1500	11,89	14,93	38,10	500
EE480-1000	12,19	15,23	25,40	500
EE480-1500	12,19	15,23	38,10	500
EE500-750	12,70	15,74	19,05	500
EE500-1500	12,70	15,74	38,10	500
EE535-750	13,59	16,63	19,05	250
EE535-1500	13,59	16,63	38,10	250
EE535-3000	13,59	16,63	76,20	250
EE562-659	14,27	17,31	16,74	250
EE562-1500	14,27	17,31	38,10	250
EE600-1500	15,24	18,28	38,10	250
EE625-1125	15,88	18,92	28,58	250
EE625-1250	15,88	18,92	31,75	250
EE625-1500	15,88	18,92	38,10	250
EE625-2500	15,88	18,92	63,50	250

CODICE CODE	A	C	L	PCS BOX
EE687-1500	17,45	20,49	38,10	250
EE687-2500	17,45	20,49	63,50	250
EE730-1500	18,54	21,58	38,10	250
EE750-1500	19,05	22,09	38,10	250
EE750-2000	19,05	22,09	50,80	250
EE750-3500	19,05	22,09	88,90	250
EE780-1500	19,81	22,85	38,10	250
EE812-1500	20,62	23,66	38,10	250
EE845-2844	21,46	24,50	72,24	250
EE875-1000	22,23	25,27	25,40	250
EE875-1500	22,23	25,27	38,10	250
EE937-1500	23,80	26,84	38,10	250
EE970-1500	24,64	27,68	38,10	250
EE1000-1500	25,40	28,44	38,10	250
EE1000-2000	25,40	28,44	50,80	250
EE1062-1500	26,97	30,01	38,10	100
EE1062-2000	26,97	30,01	50,80	100
EE1125-1500	28,58	31,62	38,10	100
EE1187-1500	30,15	33,19	38,10	100
EE1250-1500	31,75	34,79	38,10	100
EE1350-1500	34,29	37,33	38,10	100
EE1380-1500	35,05	38,09	38,10	100
EE1500-1000	38,10	41,14	25,40	100
EE1500-1500	38,10	41,14	38,10	100
EE1500-1750	38,10	41,14	44,45	100
EE1625-2000	41,28	44,32	50,80	50
EE1750-2000	44,45	47,49	50,80	50
EE1875-2000	47,63	50,67	50,80	50
EE2000-2000	50,80	53,84	50,80	50
EE2105-2000	53,47	56,51	50,80	50



FORME E DIMENSIONI PERSONALIZZATE REALIZZABILI SU RICHIESTA

WE SOLVE EVERY MASKING PROBLEM

IT Cappucci copri-faston 315 °C.

UK Square silicone caps 315 °C.

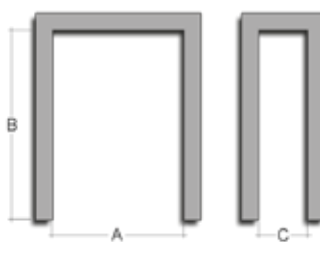

CODICE CODE	A	B	C	PCS BOX
EQ157	3,99	19,99	0,61	1000
EQ232	5,89	11,00	0,79	1000
EQ250	6,35	10,92	0,79	1000
EQ460	11,68	7,11	0,89	500
EQ470	11,94	9,50	1,02	500
EQ490	12,45	17,45	1,19	500

FORME E DIMENSIONI PERSONALIZZATE REALIZZABILI SU RICHIESTA



IT Cappucci con anelli interni 315 °C.

Gli anelli interni facilitano l'inserimento e l'estrazione su perni/filetti lunghi e di grandi dimensioni ed aumentano la tenuta del cappuccio.

UK Caps with rings 315 °C.

Internal rings allow an easy handling on long pivots/threads with big diameters and increase cap tightness.



CODICE CODE	Ød	ØD	L	PCS BOX
CBI3-6	3,00	6,00	39,00	100
CBI6-9	6,00	9,00	39,00	100
CBI9-12	9,00	12,00	39,00	100
CBI12-15	12,00	15,00	39,00	100
CBI15-18	15,00	18,00	39,00	50
CBI18-21	18,00	21,00	39,00	50
CBI21-24	21,00	24,00	39,00	50
CBI24-27	24,00	27,00	39,00	50
CBI27-30	27,00	30,00	52,00	25
CBI30-33	30,00	33,00	52,00	25
CBI33-36	33,00	36,00	52,00	25
CBI36-39	36,00	39,00	52,00	25
CBI39-42	39,00	42,00	52,00	25
CBI42-45	42,00	45,00	52,00	10
CBI45-48	45,00	48,00	52,00	10
CBI48-51	48,00	51,00	52,00	10
CBI51-54	51,00	54,00	52,00	10

FORME E DIMENSIONI PERSONALIZZATE REALIZZABILI SU RICHIESTA

IT Cappucci con flangia 315 °C.

Per la protezione di fori filettati e del primo filetto.

UK Caps with flange 315 °C.

To mask holes and first thread.

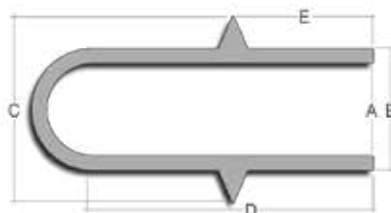

CODICE CODE	A	B	C	D	E	PCS BOX
CR8	4,39	7,39	11,99	30,99	11,99	250
CR10	5,69	8,71	13,00	32,00	14,71	250
CR12	7,65	10,69	14,00	33,02	15,80	250
CR12L	8,00	10,69	14,00	45,66	15,80	250
CR14	10,69	13,69	15,01	34,04	18,01	250
CR14L	9,55	12,70	17,02	57,15	17,53	250

FORME E DIMENSIONI PERSONALIZZATE REALIZZABILI SU RICHIESTA





Cappucci a testa piatta 315 °C.



Flat caps 315 °C.

CODICE CODE	A	C	L	PCS BOX
FC70-1000	1,78	4,82	25,40	1000
FC100-1000	2,54	5,58	25,40	1000
FC100-1120	2,54	5,58	28,45	1000
FC120-400	3,05	6,09	10,16	1000
FC120-1000	3,05	6,09	25,40	1000
FC145-1120	3,68	6,72	28,45	1000
FC148-1000	3,76	6,80	25,40	1000
FC172-800	4,37	7,41	20,32	1000
FC175-1000	4,45	7,49	25,40	1000
FC185-1120	4,70	7,74	28,45	1000
FC220-1120	5,59	8,63	28,45	500
FC220-1650	5,59	8,63	41,91	500
FC223-1500	5,66	8,70	38,10	500
FC234-1500	5,94	8,98	38,10	500
FC295-250	7,49	10,53	6,35	500
FC295-1500	7,49	10,53	38,10	500
FC300-1120	7,62	10,66	28,45	500
FC300-1650	7,62	10,66	41,91	500
FC355-1500	9,02	12,06	38,10	500
FC375-1120	9,53	12,57	28,45	500
FC375-1500	9,53	12,57	38,10	500
FC393-728	9,98	13,02	18,49	500
FC415-1500	10,54	13,58	38,10	500
FC437-1000	11,10	14,14	25,40	500
FC440-728	11,18	14,22	18,49	500
FC456-1120	11,58	14,62	28,45	500
FC456-1500	11,58	14,62	38,10	500

CODICE CODE	A	C	L	PCS BOX
FC480-1500	12,19	15,23	38,10	500
FC535-1500	13,59	16,63	38,10	250
FC562-1500	14,27	17,31	38,10	250
FC590-708	14,99	18,03	17,98	250
FC600-1500	15,24	18,28	38,10	250
FC640-900	16,26	19,30	22,86	250
FC640-2000	16,26	19,30	50,80	250
FC665-732	16,89	19,93	18,59	250
FC687-330	17,45	20,49	8,38	250
FC722-4555	18,34	21,38	115,70	250
FC728-452	18,49	21,53	11,48	250
FC730-1500	18,54	21,58	38,10	250
FC730-4000	18,54	21,58	101,60	250
FC736-728	18,69	21,73	18,49	250
FC811-728	20,60	23,64	18,49	250
FC855-1500	21,72	24,76	38,10	250
FC921-728	23,39	26,43	18,49	250
FC970-4000	24,64	27,68	101,60	250
FC980-1500	24,89	27,93	38,10	250
FC-1000-650	25,40	28,44	16,51	250
FC-1291-905	32,79	35,83	22,99	100
FC-1555-1102	39,50	42,54	27,99	50
FC-1649-1102	41,88	44,92	27,99	50
FC-1772-670	45,01	48,05	17,02	50
FC-1850-1102	46,99	50,03	27,99	50
FC-1957-1515	49,71	52,75	38,48	50
FC-2885-1000	73,28	76,32	25,40	50

FORME E DIMENSIONI PERSONALIZZATE REALIZZABILI SU RICHIESTA



WE SOLVE EVERY MASKING PROBLEM



Cappucci ad uso facilitato 315 °C.

L'anello interno migliora la tenuta del cappuccio, mentre la rondella ne permette una facile estrazione.



Easy use caps 315 °C.

Internal ring improve cap tightness and the flange in the head allows an easy handling.



CODICE CODE	A	B	C	L	PCS BOX
SZC125-2000	3,18	16,51	6,35	50,80	500
SZC135-1180	3,43	16,76	6,60	29,97	500
SZC138-1180	3,51	16,84	6,68	29,97	500
SZC156-2000	3,96	17,30	7,14	50,80	500
SZC157-1180	3,99	17,32	7,16	29,97	500
SZC165-1016	4,19	17,53	7,37	25,81	500
SZC177-1180	4,50	17,83	7,67	29,97	500
SZC180-2000	4,57	17,91	7,75	50,80	500
SZC187-1377	4,75	18,08	7,92	34,98	500
SZC187-1747	4,75	18,08	7,92	44,37	500
SZC197-1180	5,00	15,80	9,40	37,00	250
SZC234-2000	5,94	19,28	9,12	50,80	250
SZC236-1180	5,99	19,33	9,17	29,97	250
SZC255-910	6,48	19,81	9,65	23,11	250
SZC255-1180	6,48	19,81	9,65	29,97	250
SZC270-1200	6,86	20,19	10,03	30,48	250
SZC275-1180	6,99	20,32	10,16	29,97	250
SZC294-1330	7,47	20,80	10,64	33,78	250
SZC315-974	8,00	21,34	11,18	24,74	250
SZC315-1180	8,00	21,34	11,18	29,97	250
SZC315-1425	8,00	21,34	11,18	36,20	250
SZC320-670	8,13	21,46	11,30	17,02	250
SZC330-1500	8,38	21,72	11,56	38,10	250
SZC355-1500	9,02	22,35	12,19	38,10	250
SZC360-1000	9,14	22,48	12,32	25,40	250
SZC375-1000	9,53	22,86	12,70	25,40	250
SZC375-1421	9,53	22,86	12,70	36,09	250
SZC394-1180	10,01	23,34	13,18	29,97	250
SZC433-1180	11,00	24,33	14,17	29,97	250
SZC438-950	11,13	24,46	14,30	24,13	250
SZC451-1215	11,46	24,79	14,63	30,86	250
SZC485-750	12,32	25,65	15,49	19,05	250
SZC485-1013	12,32	25,65	15,49	25,73	250
SZC485-1600	12,32	26,29	16,12	40,64	250

CODICE CODE	A	B	C	L	PCS BOX
SZC492-1180	12,50	25,83	15,67	29,97	250
SZC531-1180	13,49	26,82	16,66	29,97	100
SZC586-512	14,88	28,22	18,06	13,00	100
SZC587-374	14,91	28,24	18,08	9,50	100
SZC608-493	15,44	28,78	18,62	12,52	100
SZC608-1180	15,44	28,78	18,62	29,97	100
SZC622-1180	15,80	29,13	18,97	29,97	100
SZC622-1575	15,80	29,13	18,97	40,01	100
SZC687-1180	17,45	30,78	20,62	29,97	100
SZC689-3579	17,50	30,84	20,68	90,91	100
SZC725-3120	18,40	28,56	18,40	85,10	100
SZC850-410	21,59	34,93	24,77	10,41	100
SZC906-3500	23,01	36,35	26,19	88,90	100
SZC963-3000	24,46	37,80	27,64	76,20	100
SZC980-1500	24,89	38,23	28,07	38,10	100
SZC980-1654	24,90	38,00	26,90	42,00	100
SZC1118-540	28,40	41,73	31,57	13,72	100
SZC1125-5000	28,58	41,91	31,75	127,00	50
SZC1230-5000	31,24	44,58	34,42	127,00	50
SZC1240-1760	31,50	44,83	34,67	44,70	50
SZC1288-4128	32,72	46,05	35,89	104,85	50
SZC1567-1517	39,80	53,14	42,98	38,53	50
SZC1850-1850	46,99	60,33	50,17	46,99	50
SZC1921-1575	48,79	62,13	51,97	40,01	50
SZC2244-1811	57,00	70,33	60,17	46,00	25
SZC2250-1920	57,15	70,49	60,33	48,77	25
SZC2500-2420	63,50	76,84	66,68	61,47	25
SZC2660-726	67,56	80,90	70,74	18,44	25
SZC2750-2670	69,90	84,40	74,30	69,60	25
SZC3000-2920	76,20	89,00	79,38	74,17	25
SZC3154-730	80,11	92,68	83,29	18,54	25
SZC3425-705	87,00	100,33	90,17	17,91	25
SZC3465-819	88,01	101,35	91,19	20,80	25
SZC3500-3420	88,90	102,24	92,08	86,87	25

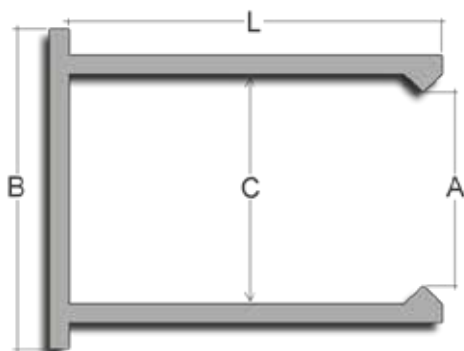

FORME E DIMENSIONI PERSONALIZZATE REALIZZABILI SU RICHIESTA

CCC



Cappucci conici a rondella 315 °C.

Indicati per rivestimenti in polvere, elettrostatici per immersione liquida e platinatura.



Silicone Conecaps 315 °C.

Recommended for powder coating, E-coating and plating.

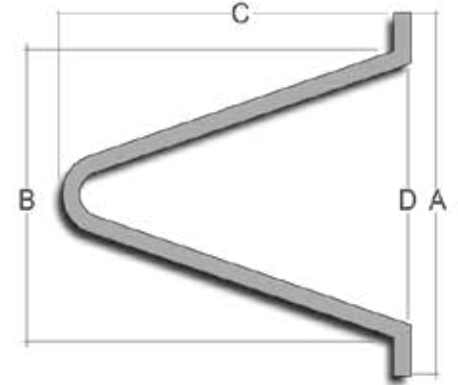

CODICE CODE	A	B	C	D	PCS BOX
CCC1	12,70	6,35	23,01	3,30	200
CCC2	12,70	8,03	25,40	5,49	200
CCC3	15,88	8,51	25,40	4,50	200
CCC4	16,51	10,01	27,99	5,00	200
CCC5	16,13	10,16	27,94	5,84	200
CCC6	19,05	14,00	35,99	8,00	200
CCC7	24,89	17,50	38,10	11,51	200
CCC8	27,94	19,48	51,03	13,51	100
CCC9	25,40	20,80	49,00	14,81	100
CCC10	30,99	22,00	53,01	16,00	100

FORME E DIMENSIONI PERSONALIZZATE REALIZZABILI SU RICHIESTA



Cappucci a rondella 315 °C.

Cappuccio a doppia funzione. Ideale per mascherare attorno a un foro per la messa a terra.



Washer Caps 315 °C.

Dual purpose plug. Ideal for masking around hole for earthing purpose.

CF



CODICE CODE	A	B	C	L	PCS BOX
CF100-500	2,54	12,70	5,72	25,40	500
CF125-500	3,18	12,70	6,40	25,40	500
CF140-500	3,56	12,70	8,20	25,40	500
CF156-500	3,96	12,70	8,00	25,40	500
CF172-500	4,37	12,70	9,70	25,40	500
CF180-600	4,57	15,24	8,00	25,40	250
CF220-500	5,59	14,99	9,09	25,40	250
CF220-787	5,59	19,99	8,71	25,40	250
CF295-500	7,49	12,70	10,49	25,40	250
CF295-700	7,49	17,78	10,49	25,40	250
CF295-1000	7,49	25,40	10,49	25,40	250
CF300-675	7,62	17,15	10,59	25,40	250
CF376-825	9,53	20,96	13,00	38,10	250
CF460-700	11,68	17,78	14,50	25,40	100
CF500-1000	12,70	25,40	15,39	25,40	100
CF616-1180	15,62	29,97	20,70	38,10	100
CF780-1475	19,81	37,47	24,69	25,40	100



FORME E DIMENSIONI PERSONALIZZATE REALIZZABILI SU RICHIESTA

WE SOLVE EVERY MASKING PROBLEM



Cappucci ventilati ad uso facilitato 315 °C.
Gli anelli interni migliorano la tenuta del cappuccio, il foro di 0.3mm evita accumuli di pressione interna.



Vent easy use caps 315 °C.
Internal ring improve cap tightness and the vent hole reduce the internal pressure.

VRZC

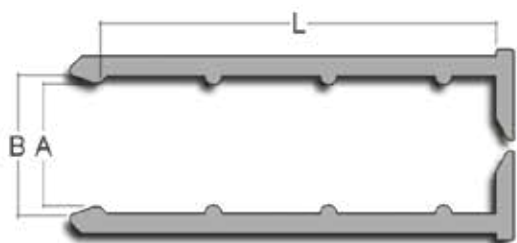

CODICE CODE	A	B	L	PCS BOX
VRZCM4	3,30	5,00	20,60	500
VRZCM5	4,40	6,18	25,60	500
VRZCM6	5,40	7,00	25,60	500
VRZCM8	7,22	9,00	25,60	500
VRZCM8L	7,22	9,00	50,60	250
VRZC10	9,22	11,00	25,60	250
VRZCM12L	11,22	13,00	50,60	100
VRZCM14L	13,22	15,00	50,60	100

ALTRE MISURE DISPONIBILI A BREVE - OTHER SIZE AVAILABLE SOON

FORME E DIMENSIONI PERSONALIZZATE REALIZZABILI SU RICHIESTA

VSP

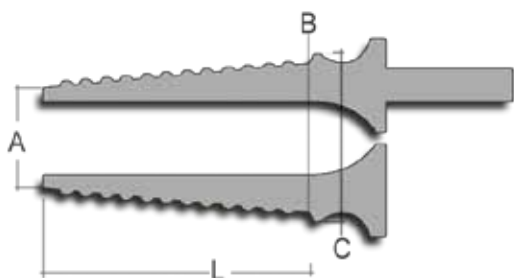

Tappi ventilati senza flange 315 ° C.
Indicati per rivestimenti in polvere, elettrostatici per immersione liquida, platinatura e anodizzazione.
Fori filettati. Forma conica e interno cavo per molteplici applicazioni.
Proteggono i fori filettati senza mascherare la zona circostante. Il foro ventilato da 0.3mm evita l'accumulo di pressione interno



Vent Flangeless Plugs 315 °C.
Recommended for powder coating, E-coating, plating and anodizing. Threaded holes. Tapered design and hollow core for multi-applications.
Protect threaded holes without masking the surrounding area. 0.3mm vent hole on top avoid pressure buildup



CODICE CODE	A	B	C	L	PCS BOX
VSP6x8	3,93	7,25	8,20	20,30	250
VSP10x12	7,50	11,00	12,40	21,50	250
VSP14x16	11,78	15,60	17,00	24,85	100
VSP18x20	15,71	19,80	21,20	26,45	100
VSP22x24	20,24	24,60	26,00	28,15	50

ALTRE MISURE DISPONIBILI A BREVE - OTHER SIZE AVAILABLE SOON

FORME E DIMENSIONI PERSONALIZZATE REALIZZABILI SU RICHIESTA

DHPP



Tappo speciale per protezione dadi a doppia maniglia 315 °C



Double handle special nut protection plug 315 °C

CODICE CODE	A	B	L	PCS BOX
DHPP05	4,10	5,40	3,00	500
DHPP06	5,10	6,70	3,80	500
DHPP08	6,70	8,70	5,35	500
DHPP10	8,50	11,20	6,60	500
DHPP12	10,10	13,00	6,60	250
DHPP14	12,10	15,20	8,00	250
DHPP16	13,90	16,60	9,30	100
DHPP18	15,90	19,80	10,50	100
DHPP20	17,80	21,01	12,30	100

ALTRE MISURE DISPONIBILI A BREVE - OTHER SIZE AVAILABLE SOON

FORME E DIMENSIONI PERSONALIZZATE REALIZZABILI SU RICHIESTA

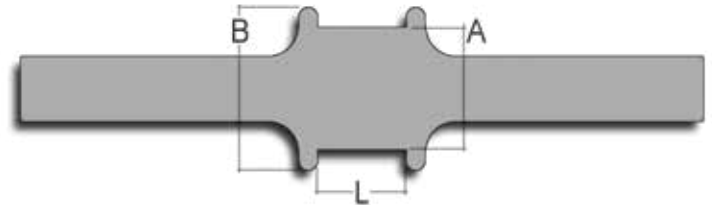

IT Tappi Doppi senza flangia 315 °C.

Protegge i fori filettati senza mascherare la zona circostante. Utile per due differenti diametri.



Double Flangeless plug 315 °C.

Protects threaded holes without masking the surrounding area. Useful for two different size

DSSF

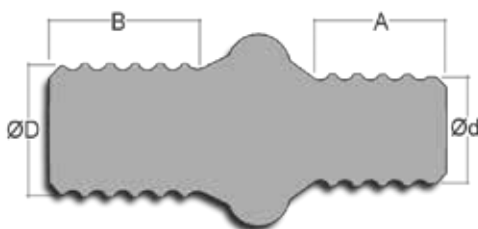

CODICE CODE	A	Ød	B	ØD	PCS BOX
DSSF6x8	7,93	5,20	7,95	7,00	500
DSSF10x12	9,33	9,00	11,74	10,80	250
DSSF14x16	12,00	12,20	14,40	14,50	100
DSSF18x20	16,80	16,50	18,60	18,00	50

ALTRE MISURE DISPONIBILI A BREVE - OTHER SIZE AVAILABLE SOON



FORME E DIMENSIONI PERSONALIZZATE REALIZZABILI SU RICHIESTA

WE SOLVE EVERY MASKING PROBLEM



Tappi con rondella maggiorata 315 °C.

Ideale per mascherare la superficie attorno ad un foro.



Silicone Large Size Flange Plugs 315 °C.

Ideal for masking holes and the grounding area around them.

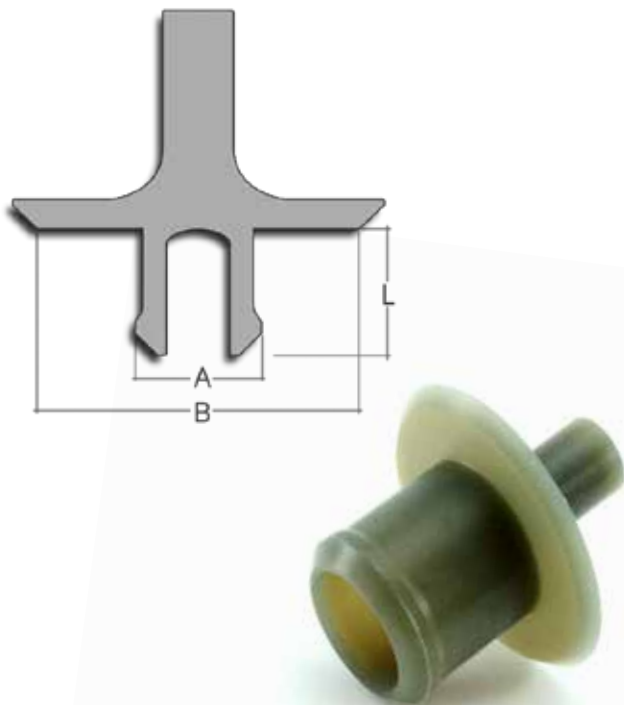

FRMP

CODICE CODE	A	B	L	PCS BOX
FRMP4x7	3,7	7,0	4,1	250
FRMP5x8	4,5	8,0	4,5	250
FRMP6x10	5,6	10,0	5,5	250
FRMP8x13	7,2	13,0	7,0	250
FRMP10x16	9,3	16,0	9,5	100
FRMP12x19	10,9	19,0	10,7	100
FRMP14x22	12,8	22,0	11,3	100
FRMP16x24	15,0	24,0	14,0	50
FRMP18x27	16,9	27,0	16,4	50
FRMP20x30	18,9	30,0	17,8	50

FORME E DIMENSIONI PERSONALIZZATE REALIZZABILI SU RICHIESTA

FZC

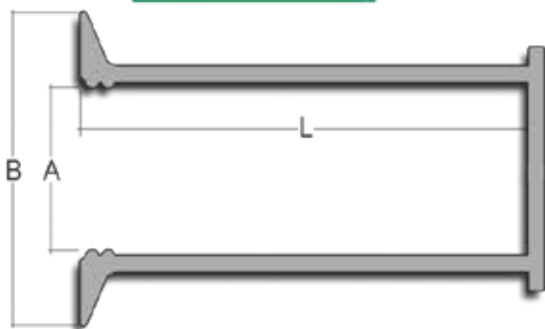

Cappucci con flangia ad uso facilitato 315 °C.

Gli anelli alla base migliorano la tenuta del cappuccio e la flangia protegge la superficie alla base del perno.



Flanged easy use caps 315 °C.

Internal ring improve cap tightness and the flange protect the area around the pin.

CODICE CODE	A	B	L	PCS BOX
FZC4x9	3,5	9,0	25,0	500
FZC5x10	4,5	10,0	50,0	200
FZC6x12	5,5	12,0	50,0	200
FZC8x16	7,4	16,0	50,0	200
FZC10x20	9,4	20,0	50,0	100
FZC12x24	11,3	24,0	50,0	100
FZC14x28	13,4	28,0	50,0	100
FZC16x30	15,4	30,0	50,0	50
FZC18x34	17,4	34,0	50,0	25
FZC20x36	19,4	36,0	50,0	25



FORME E DIMENSIONI PERSONALIZZATE REALIZZABILI SU RICHIESTA

PLASTRET



Rete in PE per protezioni e imballi.

Rete a tubo in PE a sezione variabile, ideale per imballare e proteggere manufatti cilindrici di ogni tipo.



PE net for protection and wrapping.

Variable size tube-shape PE net. Perfect to wrap and protect cylindrical shapes of all kinds

	CODICE CODE	Ødmm	ØDmm	L mt
<input type="checkbox"/>	PLASTRET07-12	7	12	25
<input type="checkbox"/>	PLASTRET12-25	12	25	25
<input type="checkbox"/>	PLASTRET25-45	25	45	25
<input type="checkbox"/>	PLASTRET45-70	45	70	25
<input type="checkbox"/>	PLASTRET70-120	70	120	25

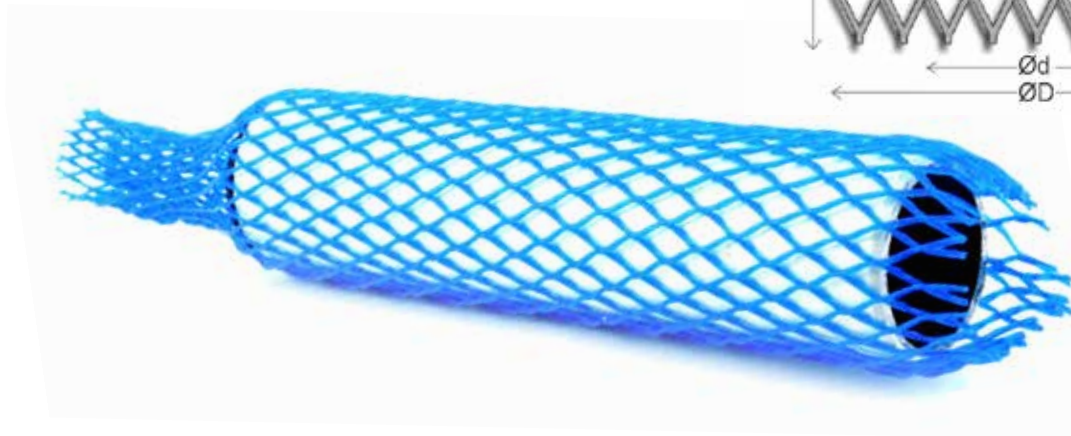
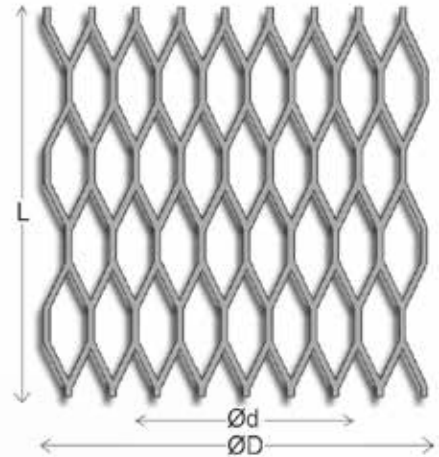

Tendi-mascherina in Silicone

Adatto a tutte le mascherine chirurgiche, evita il contatto con le orecchie dando un maggiore confort nel vestire la mascherina. Regolabile in varie posizioni.



Silicone mask extender

Suitable for all surgery mask, release ear pressure giving confort while wearing the mask. Adjustable in many positions.

Fit Mask

CODICE
CODE

FitMask Green

PCS BOX

5



Colori Disponibili
a Richiesta
Other Colors Available
on demand

Codice Code	Descrizione Description	Pag. Page
Nastri - Tapes - Rubans - Klebeband - Cintas - Fitas		
SRT	Nastro in Silicone - Silicone rubber tape	11
HPT	Nastro verde 204 °C - Green tape 204 °C	9
EPR	Nastro rosso 220 °C - Red tape 220 °C	9
EPB	Nastro blu 204 °C - Blue tape 204 °C	9
EPTL	Nastro verde 204 °C lungh.250m - Green tape 204 °C 250m length	10
STC	Nastro trasparente 204 °C (0,065 mm)- Clear tape 204 °C (0,065 mm)	10
CLT	Nastro trasparente 204 °C (0,09 mm)- Clear tape 204 °C (0,09 mm)	10
PC	Nastro polimide 260 °C - Polyimide tape 260 °C	11
EGC	Nastro in tessuto di fibra di vetro 260 °C - Glass Cloth tape 260 °C	11
FLT	Fine line tape - Fine line tape	11
RPT	Nastro verde 204 °C SILICONE FREE - Green Tape 204 °C SILICONE FREE	12
EPG	Nastro per mascherature 140 °C - Masking tape 140 °C	13
LPG	Nastro in carta per mascheratura 80°C - Semi creped paper masking tape 80°C	13
SPG	Nastro in carta ad alta temperatura 190 °C - High temperature masking tape 190 °C	13
LALL65	Nastro in alluminio con liner - Aluminium tape with liner	12
LALL70	Nastro in alluminio laminato PET - Aluminium laminated tape	12
Fustellati adesivi - Engineered tape adhesive - Découpes de rubans adhésifs - Technisches für Stanzteile - Troqueles en cinta adhesiva - Corte em fita adhesiva		
EPCL	Dischi adesivi con linguetta 204 °C - Adhesive discs with tab 204 °C	14
QPL	Quadrati in nastro verde 204 °C - Square green tape 204 °C	14
RPL	Rettangoli in nastro verde 204 °C - Rectangles green tape 204 °C	14
EPC	Dischi adesivi in nastro verde 204 °C - Green adhesive discs 204 °C	15
CLD	Bollini adesivi trasparenti 204 °C - Clear adhesive discs 204 °C	15
BPC	Dischi adesivi polimide 260 °C - Polyimide adhesive discs 260 °C	16
EBC	Bollini adesivi blu 204 °C - Blue adhesive discs 204 °C	16
EBV	Bollini adesivi in vinile - White vinyl adhesive discs	17
ELT	Bollini adesivi in carta per mascheratura 80°C - Semi creped paper masking discs 80°C	17
---	Fustellature di precisione in nastro 204 °C - Engineered precision tape die-cut 204 °C	18
Tappi - Plugs - Bouchon - Stopfen - Tapones - Tampas		
AFR	Anelli, frammenti e rondelle - Rings, tube fragments and washers	19
TMF	Tappo multi flangia - Multi flange plug	22
DFPP	Tappi speciali per protezione dadi - Nut protection special plug	22
CSINK	Tappi speciali con flangia 315 °C - Countersink Plugs 135 °C	22
CPHS	Tappi conici con maniglia 315 °C - Conical Plugs with handle 315 °C	23
ETM	Tappi copri-filetto 315°C - Thread mask 315°C	23
MHEP	Tappo conico cavo con maniglia - Hollow conical plug with handle	23
WFP	Tappi con rondella 315°C - Silicone Flange Plugs 315°C	24
SP	Tappi a gradino 315°C - Step Plugs 315°C	24
FP	Tappi senza flange 315 °C - Flangeless Plugs 315 °C	25

Codice Code	Descrizione Description	Pag. Page
HEP	Tappi conici in silicone concavi 315°C - Hollow silicone plugs 315°C	26
CPP	Tappi con maniglia di estrazione 315 °C - Pull Plugs 135 °C	27
EPP	Tappi EPDM con maniglia di estrazione 177 °C - EPDM Pull Plugs 177 °C	28
EP	Tappi conici 315 °C - Conical Plugs 315 °C	29
BP	Tappi conici EPDM 177 °C - EPDM Conical Plugs 177°C	30
VSP	Tappi senza flangia ventilati 315 °C - Vent flangeless plug 315 °C	39
DHPP	Tappi speciali doppia maniglia protezione dadi - Nut protection special plugs double handle	40
DSSF	Tappi doppi senza flangia - Double flangeless plugs	40
FRMP	Tappi a rondella maggiorata - Large size flange plugs	41
Tubi, corde - Tubing, cord - Tubes, cordes - Schläuche, Rundschnur - Tubos, cordones - Tubos, fios		
EST	Tubo cavo per rivestimenti in polvere 315 °C - Tubing for Powder Coating 315 °C	20
ETO	Cordoncino pieno per rivestimenti in polvere 315 °C - Cord for Powder Coating 315 °C	20
EZT	Tubo a stella in silicone 315 °C - Silicone star tube 315 °C	21
ASC-QSC	Corda in schiuma di silicone - Silicone foam cord	21
Cappucci - Caps - Capuchons - Kappen - Capuchones - Protetores		
EC	Rivestimenti in polvere Cappucci 315 °C - Powder Coating Caps 315 °C	31
EE	Cappucci in E.P.D.M. 177 °C - E.P.D.M. Caps 177 °C	33
EQ	Cappucci copri-faston 315 °C - Square silicone caps 315 °C	35
CBI	Cappucci con anelli interni 315 °C - Caps with rings 315 °C	35
CR	Cappucci con flangia 315 °C - Caps with flange 315 °C	35
FC	Cappucci a testa piatta 315 °C - Flat caps 315 °C	36
SZC	Cappucci ad uso facilitato 315 °C - Easy use caps 315 °C	37
CCC	Cappucci conici a rondella 315 °C - Silicone Conecaps 315 °C	38
CF	Cappucci a rondella 315 °C - Washer Caps 315 °C	38
VRZC	Cappucci ventilati ad uso facilitato - Vent easy use caps	39
FZC	Cappucci con flangia ad uso facilitato - Flanged easy use caps	41
Altri prodotti - Other items - Autres produits - Sonstige Produkte - Otros productos - Outros produtos		
CUT	Distributore automatico taglianastro - Automatic tape-cut dispenser	6
TAI	Termometri adesivi monouso - Single-use adhesive thermometers	6
STICKRP01	Stick per ritocco verniciatura a polvere - Custom made touch-up pencils for powder coating	6
PRO	Vernice spray - Spray paint	7
AAP	Pellicola autoadesiva trasparente - Clear adhesive film	8
SKIT	Starter kit - Starter kit	24
PLASTRET	Rete in PE per protezione - PE net for protection	42
FIT MASK	Tendi mascherina in silicone - Silicone mask extender	42
Ganci - Hooks - Crochets - Stahl - Ganchos - Ganchos		
HC-HV-T5-T6	Ganci per verniciatura in acciaio - Steel hooks for painting	4
SW	Ganci girevoli - Swivel hooks	4
GANCI VERT	Ganci per verniciatura di profili in Al verticali - Hooks for vertical Al profiles painting	5
---	Ganci speciali - special Hooks	5

WE SOLVE EVERY MASKING PROBLEM

EUROMASK®

IN THE WORLD

SEDE - UFFICI - PRODUZIONE
PROGETTAZIONE - MAGAZZINO

MILANO
ITALIA

🎯 FINISHING GROUP - SEDI

🌐 RIVENDITORI ESTERI

UFFICI - PRODUZIONE - MAGAZZINO

CHRZANOW
POLONIA

LERMA
MESSICO

UFFICI - MAGAZZINO

DOBRA VODA
SLOVACCHIA

SEVILLA
SPAGNA

IASI
ROMANIA

MASKLOGIK SLOVAKIA
phone +421 915 714 105
info@masklogik.com

MASKLOGIK MÉXICO
phone +52 728 284 0120
Fax +52 728 284 0121
info@masklogik.com.mx

MASKLOGIK POLAND
phone +48 326 240 020
Fax +48 326 240 020
biuro@masklogik.com

MASKLOGIK ROMANIA
phone +40 332 443 853
Fax +40 332 443 853
info@masklogik.com

MASKLOGIK SPAIN - Fle&Mask S.L.
Movíl +34 657 577 965
Móvil +34 603 216 058
ventas@masklogik.com

EUROMASK®

RISOLVIAMO OGNI PROBLEMA DI MASCHERATURA

EUROMASK®

IN ITALIA

AGENTI
&
DISTRIBUTORI



FINISHING GROUP s.r.l.

Via A. de Gasperi, 31 - 20045 Lainate (MI) - Italia

e-mail: info@euromask-shop.com

www.euromask-shop.com

Tel. +39 02 96780055 - 9691001 - n° verde 800.029.466

Fax +39 02 96782993

**per maggiori informazioni sui nostri prodotti
puoi contattare il nostro distributore di zona**