

ENTEX

The Planetary Roller Extruder

Revolutionary process engineering



We are ENTEX

The developers of the Planetary Roller Extruder

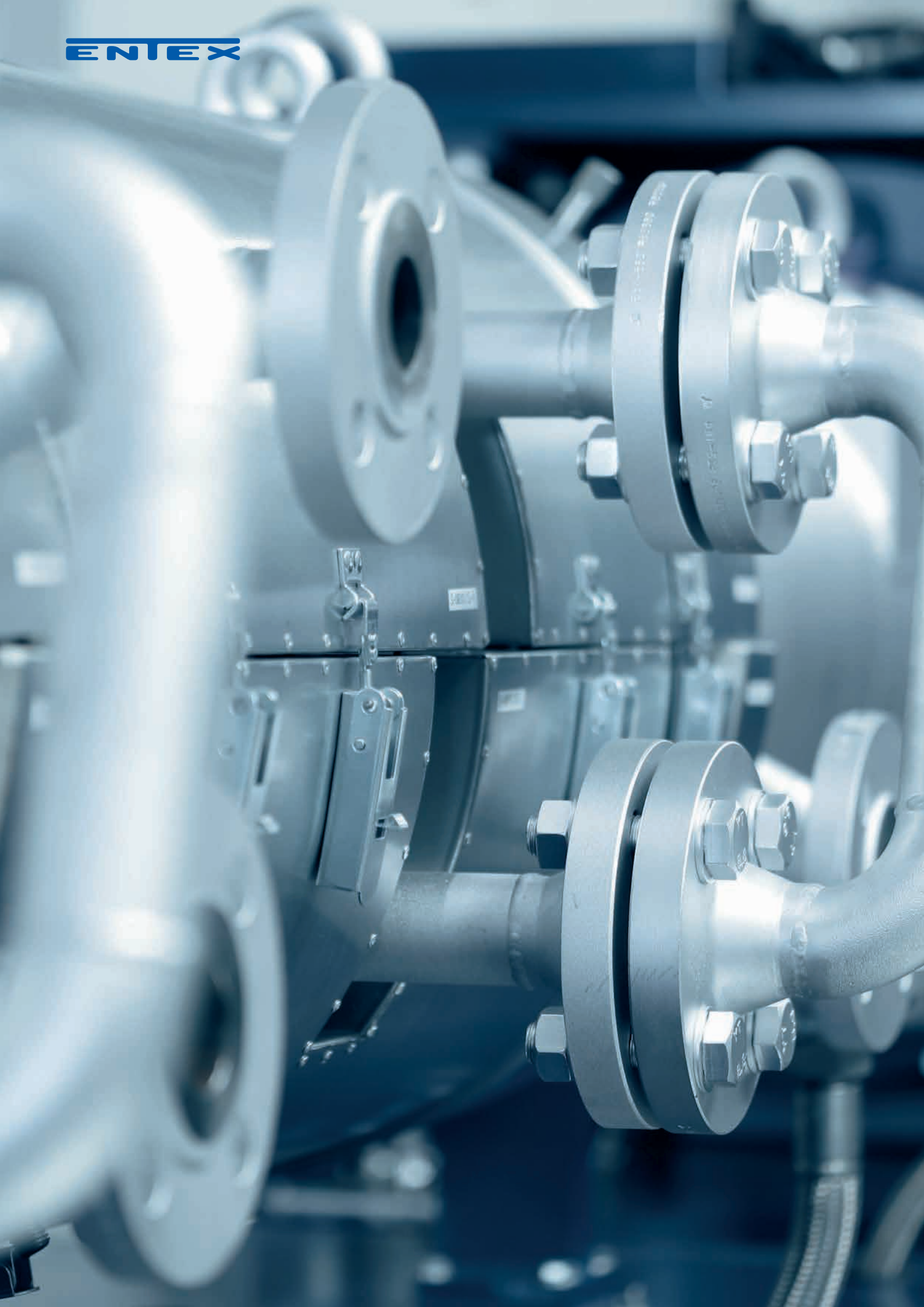



HARALD RUST

“Life is motion, swinging around a middle point.”

Harald Rust (*1949 – †2021) devoted most of his professional life to furthering the development of the Planetary Roller Extruder and expanding the use of this system to new industries and applications. In 1986 he joined with Rolf Mitschke to establish

ENTEX Rust & Mitschke GmbH

and built this company up from a small operation into an international SME. The name of ENTEX stands for “extrusion development” in German. Today, we are the industry and technology leading company in the field of extrusion technology with the Planetary Roller Extruder.

“The perfect processing machine is a symbiosis of thermodynamics and structural strength”

Innovation and the future have been the overriding focus of the company since it was founded – and Harald Rust remained at the helm until the very end. In keeping with his belief that “The perfect processing machine is a symbiosis of thermodynamics and structural strength”, Rust was always looking for new improvements and advances in extrusion technology using the Planetary Roller Extruder, so that it could be put to work in new industries and sectors at the forefront of extrusion technology.

Even in the very beginning, he and his company were able to surpass long-established competitors to achieve their position as the technological leaders in the field of extrusion with Planetary Roller Extruders. Harald Rust was many things. He was a theoretician, inventor, technician,

visionary, mentor and much else besides. “Life means never standing still. And always staying centred.” “The perfect roller has no walls”. Harald Rust was known for kicking off his technical presentations and meetings with statements like these. He channelled his passion and enthusiasm into showcasing the advantages of the Planetary Roller Extruder for his listeners and business partners. Rust never tired of explaining how they work, from little details to overarching concepts, to highlight the many possibilities that they opened up for their users.

Harald Rust also put a great deal of time and effort into helping institutes and universities train and educate the next generation while strengthening Germany as an economic hub and scientific centre.



WHAT SETS US APART

“Solutions that are sure to impress – right down to the tiniest detail”

For more than 35 years, ENTEX Rust & Mitschke GmbH has been based right in the heart of the Ruhr Region in Bochum. We have over 150 people working here to create new solutions for our customers in the field of extrusion technology.

ENTEX is the leading manufacturer of Planetary Roller Extruders. ENTEX has over 160 intellectual property rights registrations to its name since its founding.



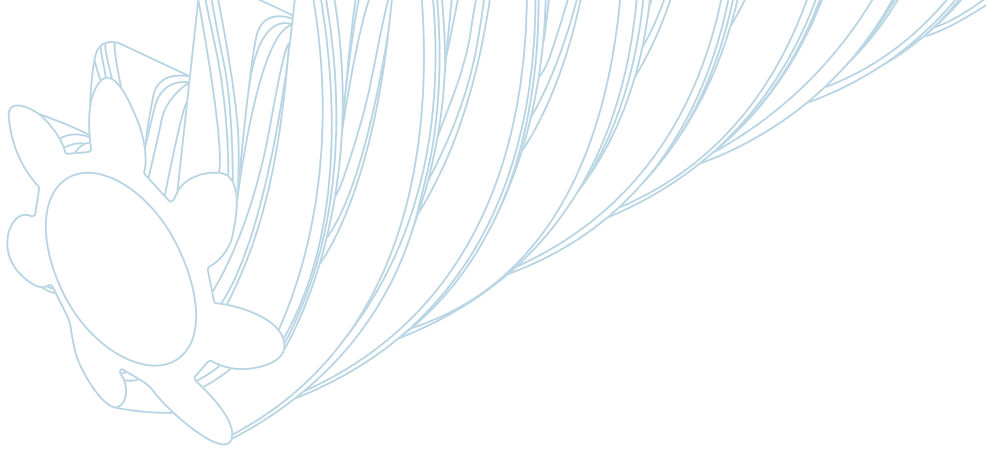

Today the ENTEX Planetary Roller Extruder covers the **full scope of compounding and process technology** for a wide range of industrial applications, including the plastics, rubber, chemicals, paint, recycling and food industries.

Thanks to its **modular concept**, the Planetary Roller Extruder offers a wide range of possibilities for compounding – even when dealing with complex reactive, cooling, degassing and mixing processes. Our Planetary Roller Extruder can also use primary energy – making it both economical and sustainable.

The company also has its own state-of-the-art testing facilities in Bochum and at its subsidiary in Shanghai for **process and product developments**.



The Planetary Roller Extruder in action – just check our animation video:





Range of applications
The Planetary Roller Extruder in action.

An overview of the many areas of application



- Complete extrusion lines based on a Planetary Roller Extruder (PRE) – all from a single source
- Extrusion systems that can be adapted thermally and mechanically for complex processes
- Suitable for a wide range of industrial applications, including the plastics, rubber, chemicals, paint, recycling and food industries
- Unit sizes ranging from laboratory extruders to full-scale production systems
- Custom tempering systems for industrial applications
- State-of-the-art testing facilities for process and product developments

Industries





CONSTRUCTION FORMS

One extruder. Various applications.

A customised solution for any challenge

Innovative process engineering for your new products and production processes – customised to suit your individual needs.





The modular principle **Modular and individually adaptable.**

Optimization for your production processes

ENTEX's unique and innovative modular system offers unprecedented economic and technical benefits.

Its modular construction allows as many as 8 roller cylinders to be connected in series.

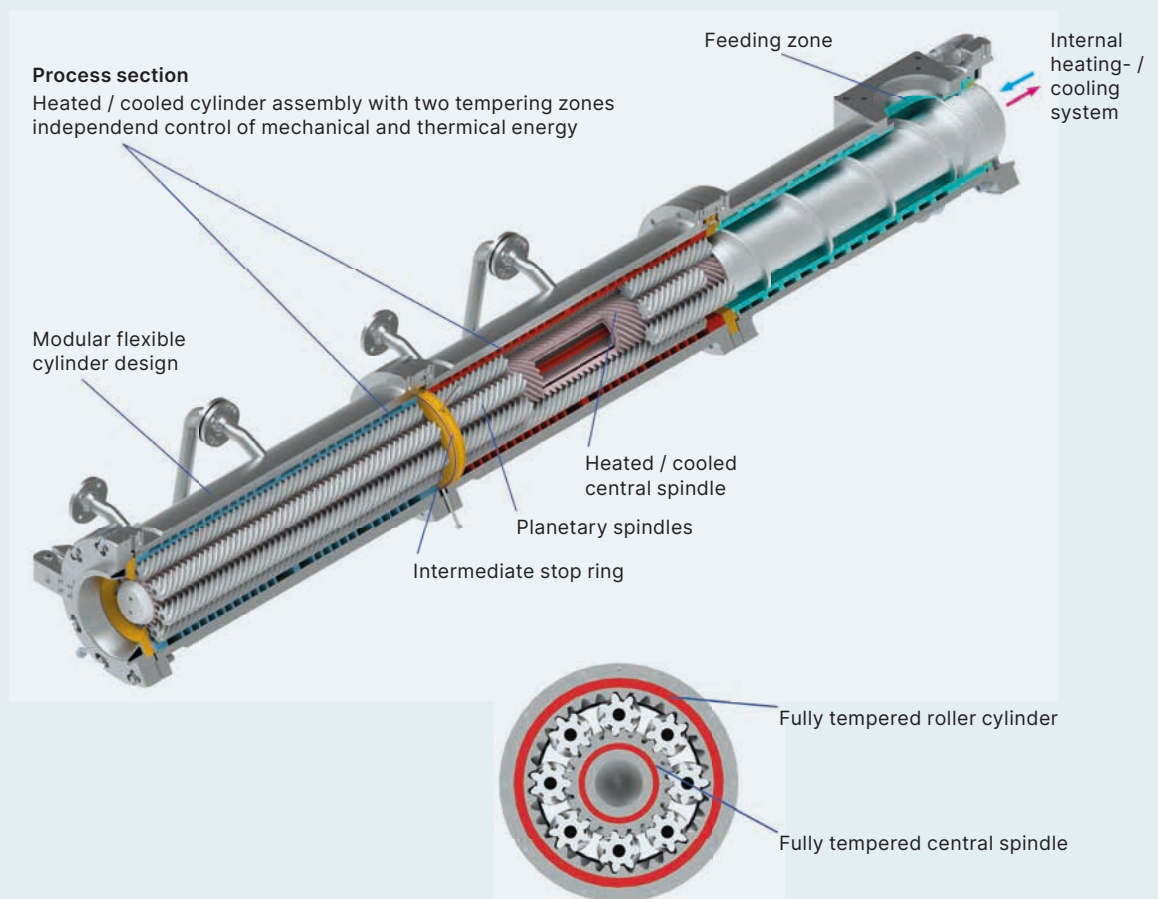



STRUCTURE AND COMPONENTS

Our plus points. Your advantages.

Process technology through the combination of several process steps

Discover the modular design of the ENTEX Planetary Roller Extruder with its mechanically controlled process zones and individual temperature-controlled zones.

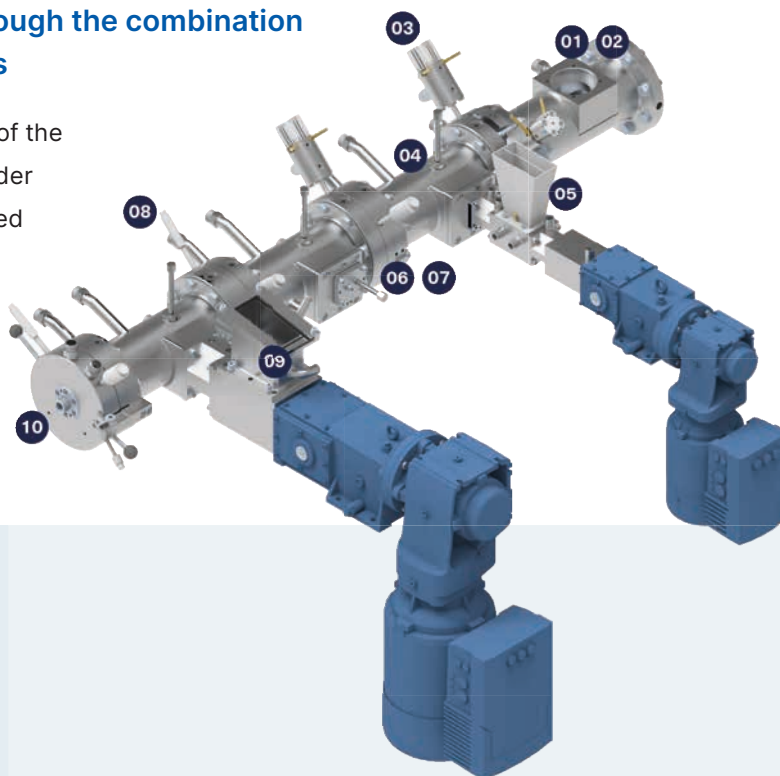

More information



01
Single screw feed cylinder



02
Planetary spindle feed cylinder

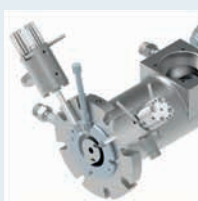

03
Injection ring / spray ring

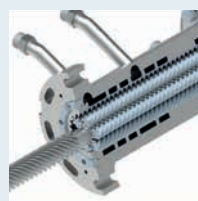

04
Roller cylinder (module)

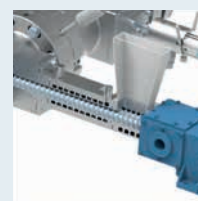

05
Side feeder for solids supply



06
Dispersion ring

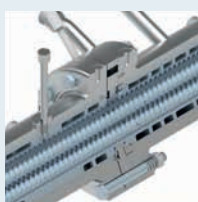

07
Toothed intermediate ring



08
Pressure, colour and temperature



09
Degassing (via side feeder)

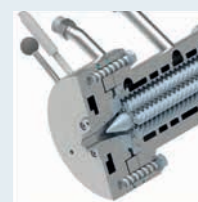

10
Discharge elements

From the product concept to industrial production **Our extruder series.**

Laboratory systems

The smallest ENTEX extrusion system is the laboratory extruder **L-WE 30**.

This unit's size makes it possible to perform series of tests for formulation and product development at laboratory scale. Thanks to its ease of use and the flexibility that results from its modular structure, the "30" series laboratory extruder can be quickly configured for individual applications.

With peripherals such as dosing units, side feeders, degassing systems, pelletisers, etc., it is possible to create complete extrusion lines. Integrated sensors measure energy inputs, pressure and temperature so that the process can be analysed and the product quality assessed.



Details
about
L-WE 30





EXTRUDER SERIES

ENTEX, a good fit in any facility.

Pilot systems – testing facilities

Our **L-WE 70** series extruders can be used for product development, process optimisation and the production of materials for customer samples.

Every step in the process for production machines can be reproduced at pilot scale.

The process section and machine frame are modular, making it possible to expand or reconfigure the system as necessary. Additional peripherals can be easily connected and integrated into the control system.



Details
about
L-WE 70





EXTRUDER SERIES

The ENTEX extrusion line.

Production systems

The configuration of the Planetary Roller Extruder is tailored to the **individual production process**.

Thanks to a modular system that is able to accommodate each individual step in the process – such as material feeding, melting, mixing in, homogenisation, degassing, etc. – and corresponding peripherals, Planetary Roller Extruders can be used to perform, optimise or replace a wide range of production processes in the adhesives, plastics, rubber, chemicals and food industries.

The modular concept makes a variety of process section lengths possible for all PRE unit sizes listed below.



Standard equipment

- Control system
- Gear motor
- Process section
- Sensor technology

Optional equipment

- Temperature Control Units (TCUs)
- Various process section lengths
- Feed screw
- Planetary feed cylinder
- Planetary spindles
- Stop rings, dispersion rings, toothed intermediate rings
- Side feeder
- Dosing units
- Injection pumps
- Degassing
- Melt pumps
- Nozzle heads
- Radial pelletisers
- Hot die-face pelletising
- Underwater pelletising

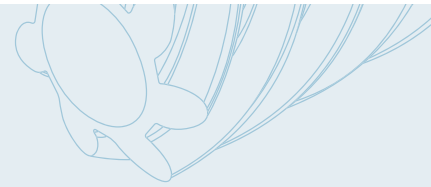

Our extruder unit sizes – an overview

Different unit sizes offer different output rates/ capacities (see table below).

These are strongly dependent on the formulation and on the technical configuration.

Size	Power [KW] up to	Speed [min ⁻¹] up to	Torque [Nm] up to	Throughput [Kg/h]*	
				from	up to
30	10	1.000	200	0,3	10
70	90	1.000	2.500	20	250
100	130	200	7.000	100	500
150	180	1.500	17.500	200	3.000
150S	220	250	20.000	200	1.000
200	280	120	50.000	500	2.000
250	350	120	60.000	500	2.500
280S	800	300	100.000	500	3.000
300	1.200	100	160.000	600	5.000
400	1.500	120	160.000	800	7.000
400S	2.300	110	240.000	1.000	12.000

 ENTEX Standard
 S = „Heavy“ Series

*depending on process

Heavy-duty series

ENTEX's 'heavy-duty' series of Planetary Roller Extruders is equipped with a larger gear module to deliver a longer service life while simultaneously reducing maintenance requirements.

Technical specifications*

Processing section length	M1–M8
Throughput	up to 12,000 kg/h
Drive power	up to 2,300 kW
Extruder speed	up to 1,500 rpm
Drive torque	up to 240,000 Nm
Max. process pressure	200 bar
Max. process temperature	up to 430 °C

* Depending on the unit size and formulation (see table above)



Thermodynamics The highest degree of temperature control.

Precise and efficient temperature control

The importance of heating and cooling technology cannot be overestimated – and not just for extrusion processes. It is a key determinant of product quality, and plays a major role in resource conservation and economic efficiency.

ENTEX has developed its own temperature control units to ensure that its Planetary Roller Extruders enjoy top of the line tempering. In fact, these units are now also being used outside the field of extrusion technology.



Application areas

- Plastics industry
- Rubber industry
- Chemicals industry
- Pharmaceuticals
- Composites
- Electronics
- Wood processing
- Paper industry
- Mechanical engineering (OEM)

Typical uses

- Extruders
- Rollers
- Presses
- Tanks
- Tools
- Mixers



TEMPERING SYSTEMS

The right temperature at the right time.

Equipment features

ENTEX temperature control units utilise high-quality materials, fittings and instruments to ensure the best-possible system availability.

It goes without saying that ENTEX complies with the applicable standards and guidelines,

including DIN 4754 (for organic heat transfer media / thermal oil), DIN 4752 (for water), the EMC Directive 2014/30/EU, the Machinery Directive 2006/42/EG, the Pressure Equipment Directive DGRL 2014/68/EU and the AD2000 Regulations.

Performance range

Dynamic 140–220

Temperature range	140–220 °C
Throughput	3–75 m ³ /h
Heating capacity	6–350 kW
Cooling capacity	10–750 kW

The modular Dynamic 140–220 series uses water (pressurised) as a heat transfer medium.

Dynamic 300–430

Temperature range	300–430 °C
Throughput	3–75 m ³ /h
Heating capacity	6–350 kW
Cooling capacity	10–750 kW

The modular Dynamic 300–430 series uses thermal oil (pressurised > 350 °C) as a heat transfer medium.



THERMODYNAMICS | Heating and cooling with state-of-the-art technologies



PETEC toll compounding Added value for our customers. It goes on!

Partnership and

While the feasibility of the process is tested in the ENTEX technical center and thus the basis for the configuration of the Planetary Roller Extruder is determined, PETEC takes over the production.

Be it for customer samples and market entry, process optimisation to increase throughput, or – if the ROI (Return on Investment) does not immediately justify investing in your own equipment – toll compounding for all your production requirements, PETEC takes care of it all.



Fillers



Fibres



Degassing
Drying



Reactive
extrusion



Gentle
material
processing



Preparation of
recycling
materials

The performance range from PETEC

- Three state-of-the-art extrusion lines
- Consistently high processing quality
- Compounding contracts on schedule
- 17,000 t/a production capacity
- Inhouse laboratory

Custom compounding to order.
ENTEX technology at your service.

Visit us





PARTNERSHIPS

Compatible with the best.

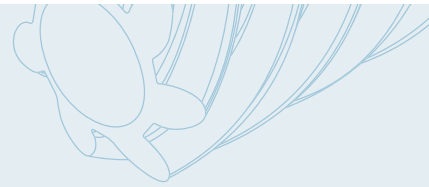

Our partners



Market entry | process optimization | toll compounding



VISIT OUR TESTING FACILITY

Our state-of-the-art facilities are at your service.

We work with you to develop innovative solutions

Do you have an idea for a new product?
Would you like to optimise your production process?
Tired of batch processes and ready for continuous production?

Our team of experts can help you throughout the process – be it planning and conducting feasibility studies, producing sample materials, planning tests or optimising processes.

Test your product on site.



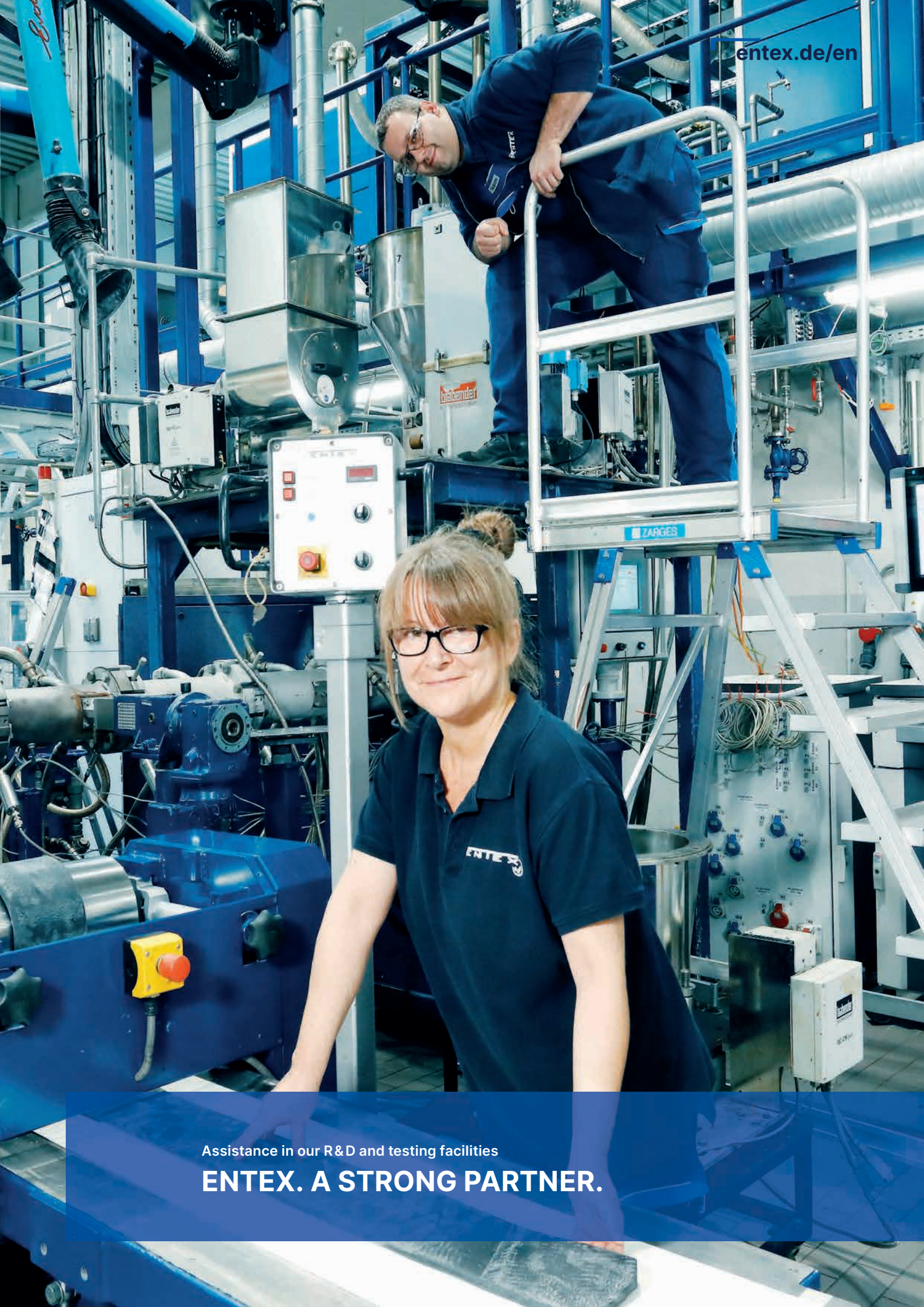

Assistance in our R&D and testing facilities

ENTEX. A STRONG PARTNER.

Follow us!



We would be pleased to advise you

VISIT US

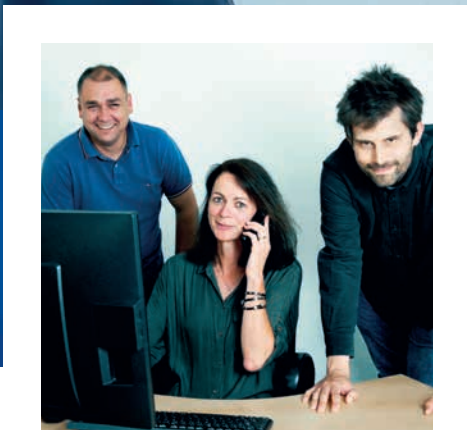

ENTEX Rust & Mitschke GmbH
Heinrichstraße 67 a
44805 Bochum | Germany

info@entex.de | www.entex.de/en
Phone +49 (0) 234 891 22 0
Fax +49 (0) 234 891 22 99