



Hot Runners • Controllers • Auxiliary Injection • Co-injection

# PRODUCT GUIDE



**THE WORLD'S LEADING SUPPLIER OF HOT RUNNER TECHNOLOGY AND SYSTEMS**

We design and manufacture hot runner solutions to optimize molding processes, improve efficiency and reduce resin waste. All with the end goal of helping our customers produce complex, accurate and aesthetically-pleasing plastic products at the highest possible levels of productivity.

**TECHNOLOGICALLY ENGINEERED TO DRIVE DOWN PART COSTS**

Run faster cycle times, reduce part scrap, achieve best in class color change times combined with the most reliable and energy efficient heating system. These advancements are why Mold-Masters focuses on and invests so much in innovative technology.

**READY FOR ANY CHALLENGE**

Our team of knowledgeable and experienced engineers have the capability and dedication to find solutions to your most demanding applications. With resources on hand like CAE, FEA simulations and an extensive applications library combined with our due diligence you have the ideal foundation for success.

**GLOBAL MANUFACTURING FOOTPRINT AND CAPACITY**

With six major hot runner production facilities on four continents and MasterCARE aftermarket service centers globally, no company can support global tooling and molding customers like Mold-Masters. Speed to market, global capacity and local market support...unparalleled.

With over 153,000 systems in use worldwide, the biggest players across every possible plastics market segment depend on Mold-Masters hot runner technology.

**INNOVATION**

With over 900 active patents, Mold-Masters continues to drive the injection molding industry. Through our dedicated R&D center, the continuous search for new ways to improve mold performance and enhance molded part quality has led to the creation of industry leading innovations such as iFLOW Manifold and Brazed Heater technologies. These technologies, and many more, are incorporated into the products we offer.

**SERVICE AND SUPPORT YOU CAN COUNT ON**

We support you for the entire lifecycle of your mold with our global MasterCARE™ teams and innovative services such as STAMP™ and e-STORE. Our knowledgeable and passionate people are committed to providing the best customer care experience in the industry.

**Plus we offer the best warranty in the industry.**



**GLOBAL SUPPORT AND SERVICE YOU CAN COUNT ON**

Once you receive your Mold-Masters hot runner system and begin production, you're in the experienced hands of our MasterCARE aftermarket service professionals.

Working diligently to ensure your operation runs smoothly, MasterCARE personnel are your service partners that provide rapid global support with a range of services designed to maintain part quality, maximize uptime and minimize unscheduled interruptions. Contact MasterCARE today to unlock your operations full potential.

- Preventative Maintenance.
- Refurbishment.
- MasterCARE Academy.
- Remote Technical Support.
- Service and Repair.
- Spare Parts.



**LARGEST GLOBAL FOOTPRINT**



# SOLUTIONS FOR EVERY APPLICATION

	Consumer Goods	Electronics	Medical	Personal Care	Technical	Cap & Closure	Packaging	White Goods	Automotive	PET / Preforms
<b>Hot Runners</b>										
Summit-Series	•	•	•	•	•	•	•	•	•	
Master-Series	•	•	•	•	•	•	•	•	•	
Sprint						•				
ThinPAK-Series							•			
VelocityLS	•			•			•	•		
Fusion-Series G2							•	•	•	
Dura+							•	•	•	
Axiom/PET-Series										•
Co-injection			•		•	•	•		•	•
<b>Advanced Gating</b>										
Accu-Valve	•	•	•	•	•	•	•	•		
Melt-CUBE/Disk			•	•	•					
Tit-Edge	•		•	•						
Core Ring	•	•	•	•	•	•				
<b>Actuation Control Systems</b>										
SeVG+	•	•	•	•	•		•	•	•	
E-Drive/P-Drive/H-Drive	•	•	•	•	•	•			•	
SVG	•			•		•	•	•	•	•
<b>Temperature Controllers</b>										
TempMaster M3	•	•	•	•	•	•	•	•	•	•
TempMaster M2+	•	•	•	•	•	•	•	•	•	•
TempMaster M1+	•	•	•	•	•	•	•	•	•	•
TempMaster MT	•			•			•	•	•	•
TempMaster ME	•			•			•	•	•	•
<b>Process Systems</b>										
M-Ax	•	•	•	•	•	•	•	•	•	•
TempMaster WFM	•	•	•	•	•	•	•	•	•	•
<b>Specialty Equipment</b>										
E-Multi/E-Multi LSR	•	•	•	•	•	•	•	•	•	•
Co-injection CONNECT			•		•	•	•		•	•
LSR Cold Deck	•	•	•	•	•				•	

## INDUSTRY LEADING WARRANTY



Please speak to a MM representative for complete warranty details. Some conditions and/or limitations apply. Subject to change without notice.

# AVAILABLE GATING STYLES



## NON-VALVED

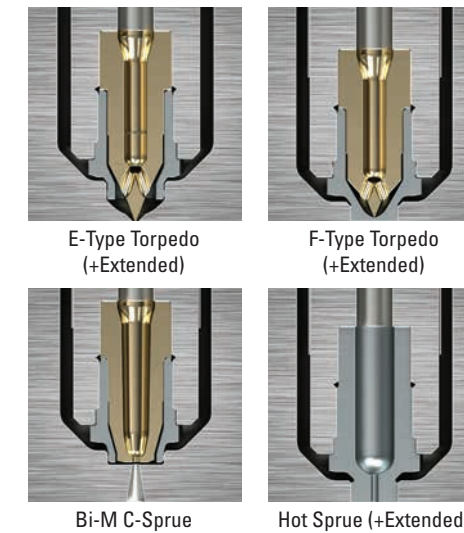

## VALVED

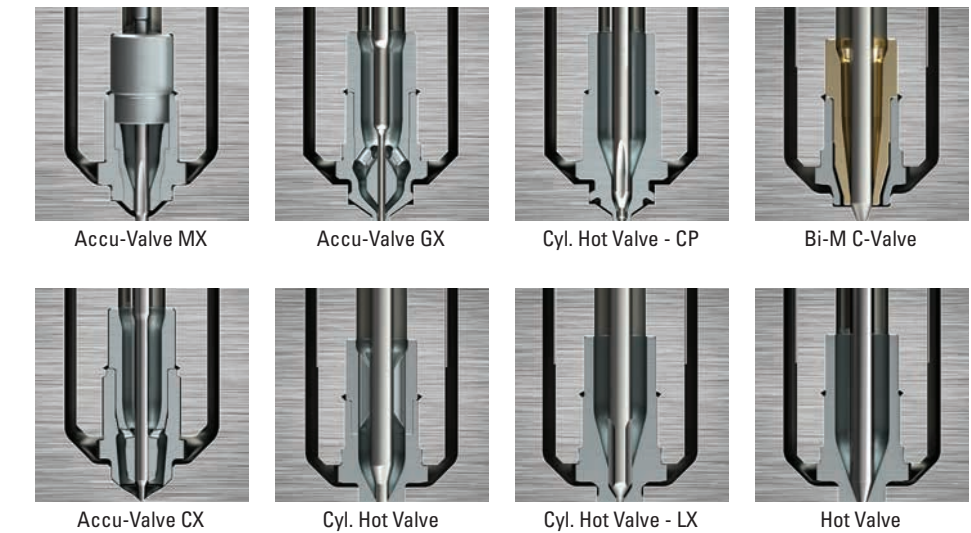

## ADVANCED CAPABILITIES

- High Cavitation.
- Tight Pitch.
- Inside Gating.
- Side Gating.
- Multi-tip.
- Stack Molds.
- Multi-material.

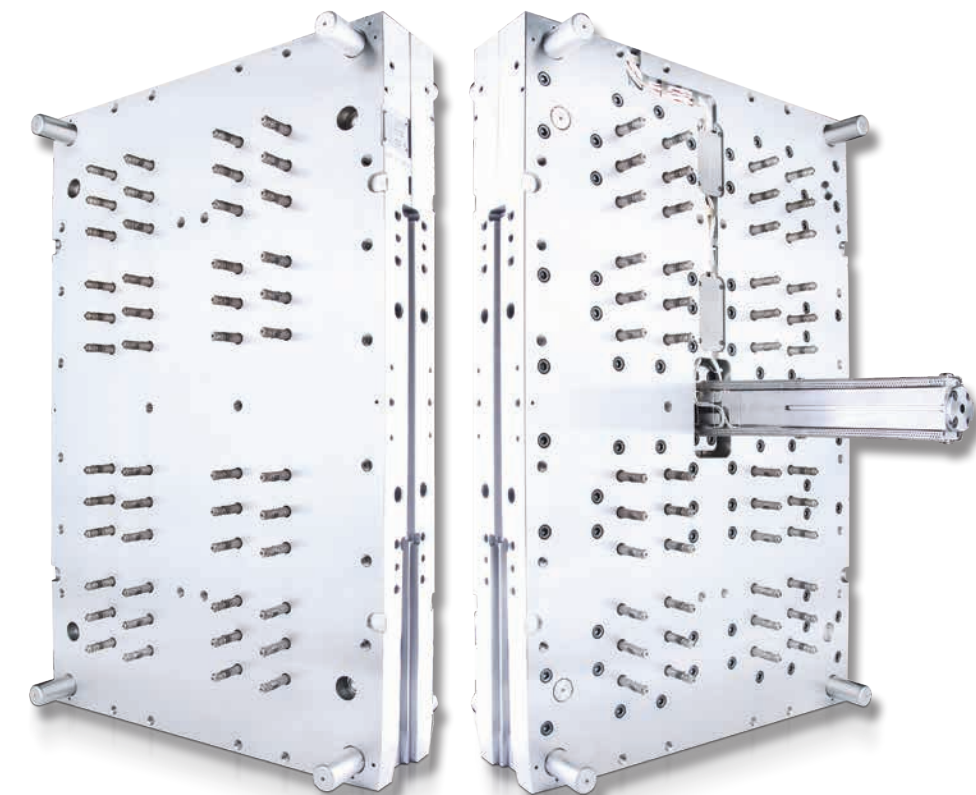

# TECHNICAL ADVANTAGES

Mold-Masters has over 900 active patents and has been in business for over 50 years. It is our engineering designs and vast application experience that differentiates us. We deliver products that outperform the competition in the simplest to the most challenging and technical applications. Our customers typically only see the results: Superior production quality, increased productivity and lower operating costs. No two hot runner suppliers are the same. Unlock your operations full potential with Mold-Masters original technology.

### BEST IN-CLASS MELT MANAGEMENT

- A result of iFLOW Manifold Technology.
- Superior management of melt characteristics including shear, temperature, pressure drop and more.
- Patented melt flow geometry, flow path options and runner shapes.
- Extensive flexibility for design optimization.
- Industry leading mold fill balance.
- Rapid color change performance.

### SUPERIOR THERMAL MANAGEMENT

- A result of Brazed Heater Technology.
- Especially valuable for processing materials with shear or temperature sensitivities.
- Superior thermal profile precision.
- Improves thermal balance across the whole system.
- Minimizes process variability (drop-drop/shot-shot).
- Significantly improves part quality and reduces scrap.

### PRECISE TEMPERATURE CONTROL

- A result of TempMaster APS Control Technology.
- Proprietary Auto-Tuning Algorithm.
- Automatically adapts to process variables of each zone.
- Precise control accuracy minimizes variability.
- Optimizes the performance of any hot runner system.

### HIGHLY TECHNICAL APPLICATION EXPERIENCE

- Capabilities that include Co-injection Technology.
- A specialized process that allows 2 resins to be combined into a single 3-layer melt stream.
- Used to enhance part performance and cost without any penalty to cycle time.
- Compatible with high performance barriers, bio-resins and PCR/scrap.

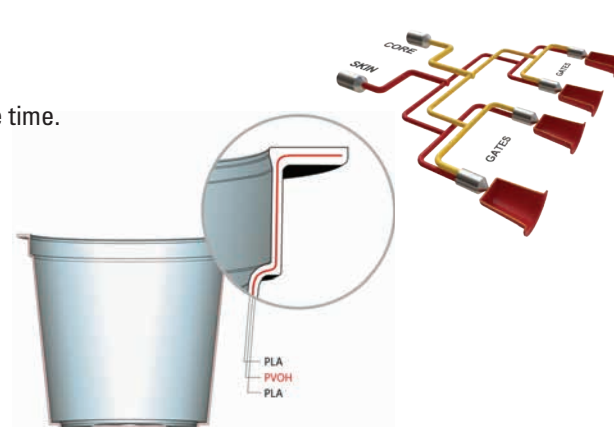
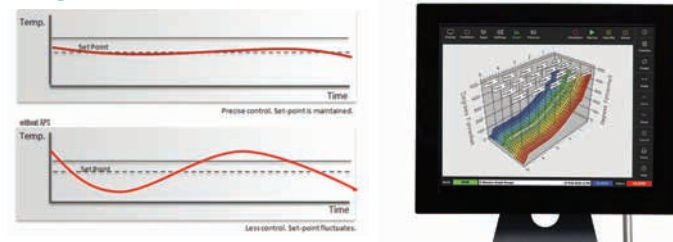
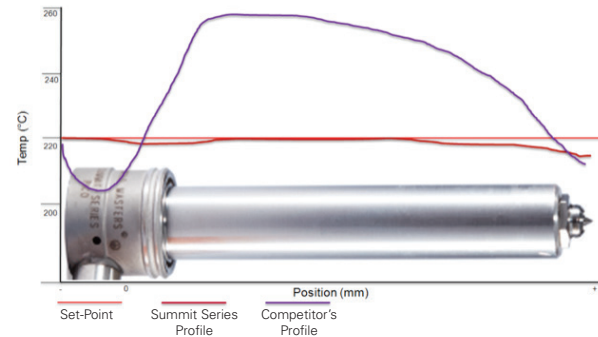
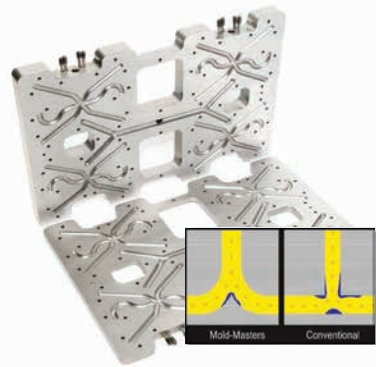

# DELIVERING CUSTOMER RESULTS

### OPTIMAL BALANCE PERFORMANCE: 1.7% TOTAL VARIANCE ON SMALL TECHNICAL PARTS

When Mold-Masters technology and decades of experience comes together anything is possible. Our customers rely on our high performance capabilities to deliver solutions where others fall short. iFLOW can deliver precision mold balance with total variation to within 1.7% on small, difficult to mold, highly technical, medical components. Unlock your operations full potential with Mold-Masters technology.

### APPLICATION DETAILS

Application: Medical  
Part: Rear Barrel  
Cavities: 32  
Material: MABS  
Part Weight: 0.35g  
Shot Weight: 11.2g

Lightest: -1% (0.0035g)  
Heaviest: +0.7% (0.0025g)  
Percent Fill: 96.5%

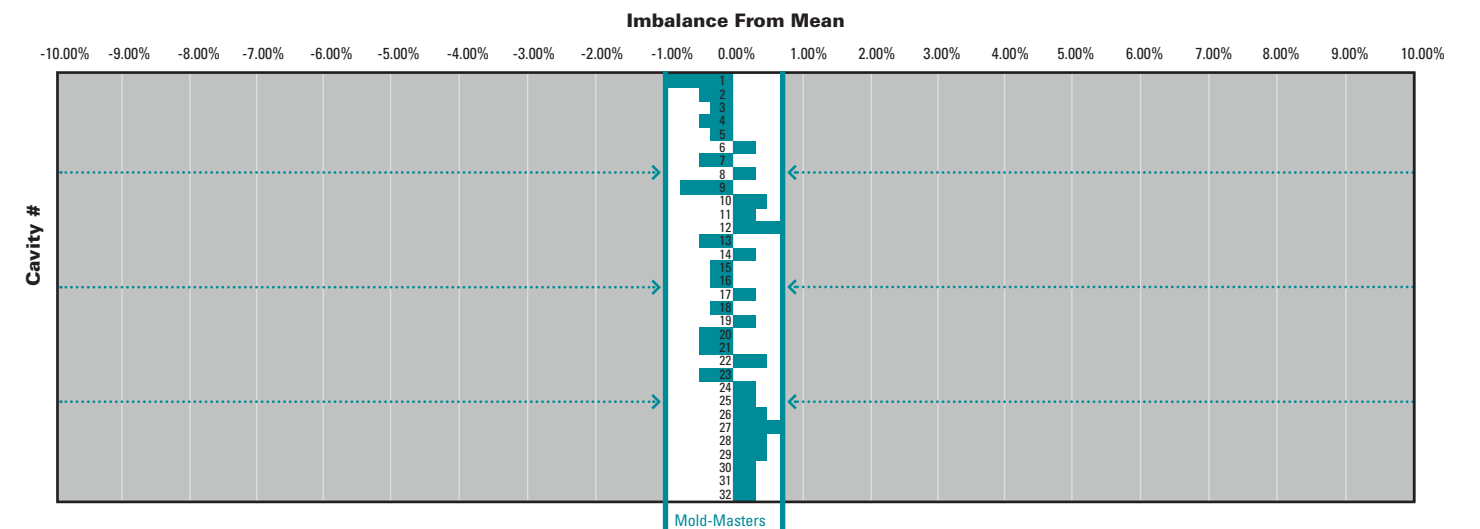
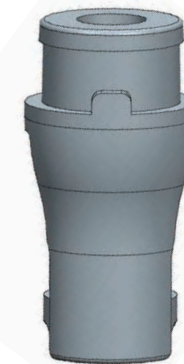

# Bio-Resin

LEADING THE INDUSTRY IN APPLICATION EXPERIENCE, KNOWLEDGE AND SUCCESS

Mold-Masters recognizes the importance Bio-Resins represent in helping to preserve the environment for future generations. We have invested considerable time and money in understanding these cutting edge materials to ensure we're ready when you are. Trust in Mold-Masters to drive positive results on your next Bio-Resin application.

Contact us at [Bio-Resins@moldmasters.com](mailto:Bio-Resins@moldmasters.com)

## UNDERSTANDING BIO-RESINS

Bio-Resins can be very challenging to process compared to the common resins they typically aim to replace. This of course can make producing good parts very difficult and sometimes impossible.

## IMPORTANT CONSIDERATIONS

Obviously, many Bio-Resin grades differ from one to the other. Some can be easier to process than others but it is common for many to have narrow process windows due to Thermal or Shear sensitivities.

Additionally, if the Hot Runner design is not optimized for Bio-Resins, this can also be a source or even compound the issue. Therefore, taking into consideration Flow Pattern, eliminating hang-up spots and other design requirements are also critical elements that need to be considered.

## TYPICAL PROCESSING CHALLENGES

When molding with Bio-Resins, a wide range of visual defects can appear based on the processing characteristics of the material and the hot runner configuration used. These defects include:

- Jetting.
- Streaking.
- Splay.
- Flow Marks.
- Knit Lines.
- Burn Marks.
- Stringing.



## EXTENSIVE TESTING AND EXPERIENCE

Mold-Masters has spent extensive time testing a wide selection of these materials in our R&D facility and partnered with the University of Massachusetts. This research has allowed us to evaluate and understand their unique properties and effective processing requirements.



Most importantly, Mold-Masters has a variety of real world application experience which includes high cavitation production tools that have been in long term production.

## CRITICAL KNOWLEDGE DATABASE

Mold-Masters Bio-Resin application success is directly related to our experience and our ability to pull information from our invaluable Applications Library. This data directs our team to select the correct product line(s) and assists us in designing the most optimum solution given the material at hand.

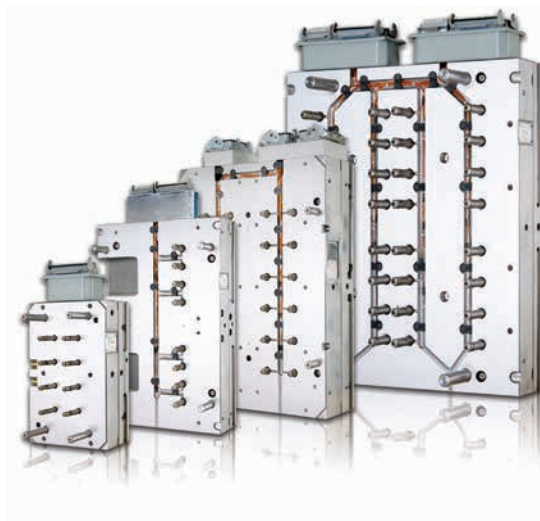

# Accu-Valve®

ACHIEVE THE HIGHEST QUALITY GATES, RELIABLY, FOR MILLIONS OF CYCLES

Precision cylindrical gate component alignment that significantly minimizes wear that leads to gate quality deterioration. Avoid the costly maintenance and downtime associated with traditional valve gate designs. Compatible with both commodity and engineering grade resins, Accu-Valve meets the demanding needs of many medical, packaging and personal care applications.

## KEY FEATURES

### PRECISION ALIGNMENT

- Highest quality gate results.
- Minimizes maintenance requirements.
- Significantly lowers operating costs.
- 1 year (3 million cycle) warranty available\*.

### CONTINUOUS 360 DEGREE VALVE PIN GUIDANCE

- Does not require direct reliance on cavity steel for pin alignment.
- Significantly minimizes wear of the gate and valve pin.
- Maintains critical high tolerance dimensions and concentricity.
- Enhances reliability.
- Extends service life.

### ENHANCED THERMAL PROFILE

- Uninterrupted heat transfer to the valve pin.
- Helps to enhance gate cosmetics.

### WIDEST SELECTION

- 3 models to choose from.
- Optimized designs based on the application.
- Capable of rapid cycle times.

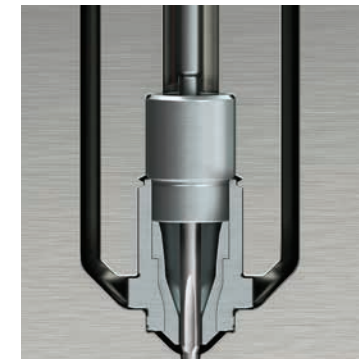

**ACCU-VALVE MX**  
(Enhanced fill balance)

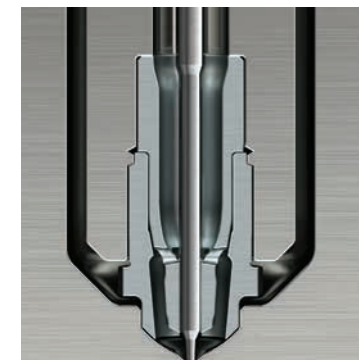

**ACCU-VALVE CX**  
(Enhanced color change)



**NEW ACCU-VALVE GX**  
(Simplified Maintenance)



\*Bio-Resins include, but are not limited to bio sourced,compostable, industrial compostable and bio-degradable materials.

# GENERAL PURPOSE

- ENHANCE PART QUALITY • MAXIMIZE PRODUCTIVITY • FAST COLOR CHANGES • LOWER PRODUCTION COSTS

Mold-Masters understands and supports the needs of our customers in a wide range of applications from the simplest to the most technical. Our capabilities extend to many industries including Consumer Goods, Personal Care, Electronics and many more. Our hot runner systems are focused on producing the highest quality parts with a wide range of materials while lowering your total cost of ownership by maximizing yield, lowering energy consumption and minimizing downtime. Supporting these markets are our proven hot runner systems, which make up our core product line, along with our extensive successful application experience. You can expect better performance and results from Mold-Masters. We have the solution you've been looking for to unlock your operations full potential.

## CONSISTENT HIGH QUALITY PRODUCTION

Mold-Masters hot runner systems are optimized for each application. A common element to the success of our core hot runner products is that they incorporate Mold-Masters original Brazed Heater Technology for excellent thermal profiles. Brazed Heaters are embedded within the steel, unlike conventional heaters that sit on top. This maximizes thermal transfer efficiency to lower energy consumption and eliminates shifting that can lead to cold spots. The result is greater process consistency, both shot-to-shot and drop-to-drop.

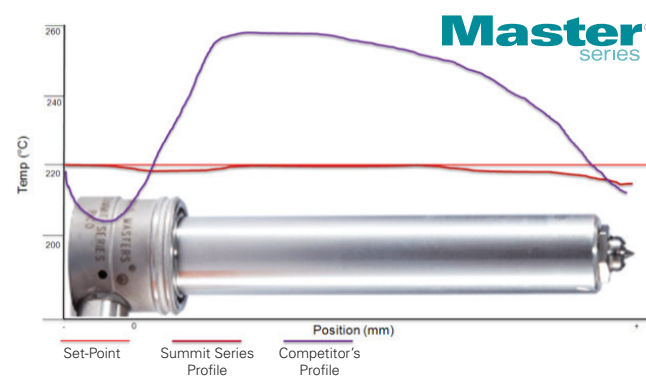

## FAST COLOR CHANGES

Optimized runner channels of Mold-Masters iFLOW Manifold Technology eliminates sharp corners and dead spots to improve color change by up to 45%.

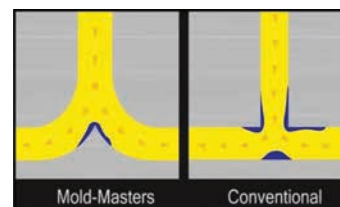

## SUPERIOR RELIABILITY

Mold-Masters implements a wide range of engineering into our hot runner designs that improves reliability and extends service intervals. Our most notable is our Brazed Heater Technology. Brazing-in the elements eliminates air gaps that cause electrical arcing, the most common root cause for heater failures. We have systems that have been in production for over 20 years that are still using the original heaters they were shipped with. This superior reliability is why Mold-Masters is the only hot runner supplier to offer a 10-Year Warranty. Conventional heaters can be unreliable which generally need to be replaced every 1-3 years at considerable cost and time. How much have conventional heaters cost your business?

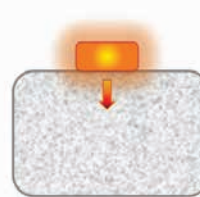

Conventional Heaters

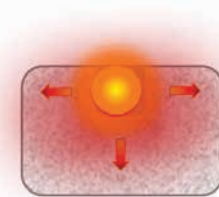

Brazed Heater Technology



# VelocityLS

Performance. Accelerated!

## CONFIGURABLE HOT RUNNERS, DELIVERING PERFORMANCE AND VALUE, FAST.

The hot runner system that can be combined with a wide range of popular standard 1-8 drop manifold configurations. Allows simple projects to get off the ground faster and more economically. Inject Velocity into your next project and bring your business up to speed.

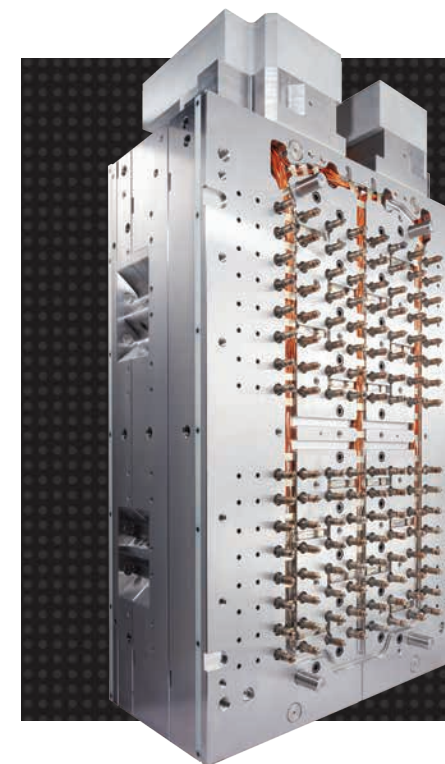
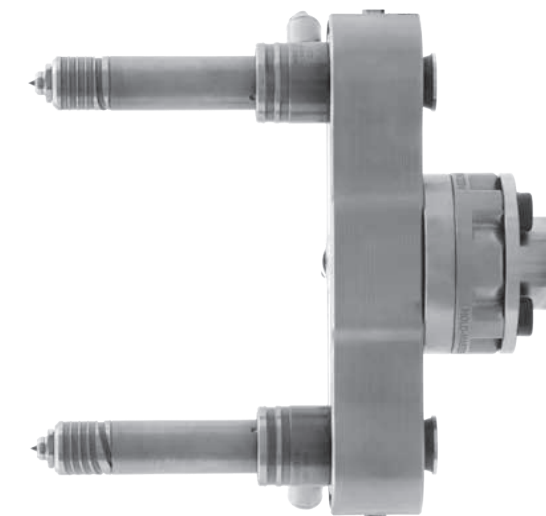

# Master<sup>®</sup> series

## THE BENCHMARK IN HOT RUNNER PERFORMANCE AND RELIABILITY

Proven to deliver consistent high performance processing capabilities for exceptional part quality. Compatible with a wide range of resins, Master-Series is the ideal choice for almost any application across any industry.

- Excellent thermal profile.
- Broadest nozzle range.
- Advanced capabilities.
- Energy efficient.

# Accu-Line™

## EASY, ECONOMICAL SINGLE CAVITY VALVE GATING

An advanced inline design able to reduce stack heights by up to 67%. Proven to deliver consistent high performance processing capabilities for exceptional part quality. Available with the broadest shot range capacity and widest range of resin compatibility. The ideal choice for high volume production or prototyping, of the smallest to largest parts, with applications across any industry.



# MEDICAL

• HIGHEST QUALITY PRODUCTION • COMPLEX GEOMETRIES • TIGHT TOLERANCES • CHALLENGING MATERIALS

Mold-Masters understands the medical industry and delivers solutions that supports the needs of our customers. Our hot runner systems are focused on exceptional process control that produce parts of the highest quality, both in tolerance and visual appearance, regardless of the material. Supporting this market are our extensive selection of hot runner systems, Accu-Valve cylindrical gating styles, side gating options, control systems, auxiliary injection units and much more. Mold-Masters extensive product line, combined with our application experience, has the medical solution you've been looking for to unlock your operations full potential.

## PROCESSING CHALLENGING MATERIALS



Glass fiber reinforced POM

Mold-Masters hot runner systems are optimized for each application. A common element to the success of our core hot runner products is that they incorporate Mold-Masters original Braze Heater Technology for excellent thermal profiles. Braze Heaters are embedded

within the steel, unlike conventional heaters that sit on top. This maximizes thermal transfer efficiency to lower energy consumption and eliminates shifting that can lead to cold spots. The result is greater process consistency, both shot-to-shot and drop-to-drop.

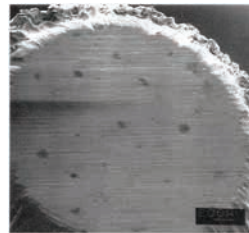

Corrosion and Abrasion damage on valve pin

## PRECISE THERMAL PROFILES

When dealing with resins with shear and temperature sensitivities, it is critical to ensure the hot runner system being used has a precise thermal profile. Thermal variabilities of the system can significantly affect mold balance and overall part quality. Part defects can appear as a result of degradation. While Mold-Masters Master-Series hot runner systems have excellent thermals, our most precise thermal profiles can be found on our Summit-Series systems. Summit-Series incorporates our most advanced proprietary heater technology that differentiates it from all of our other systems.

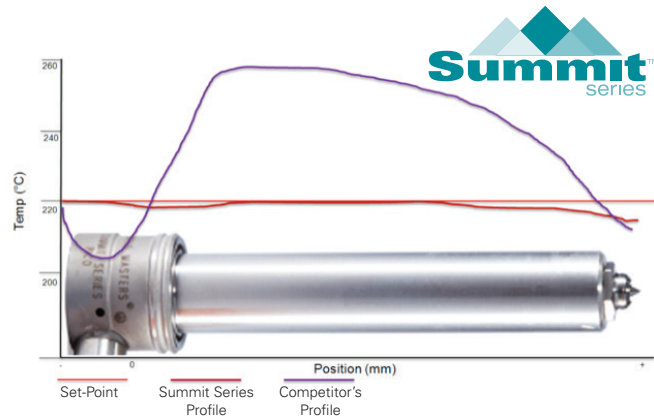

## CLIMBING TO NEW PERFORMANCE HEIGHTS

The industry's latest advancement in hot runner technology delivering peak performance and ultimate precision. Ideal for molding with today's challenging abrasive, corrosive, shear and temperature sensitive resins like PC, POM & PBT. Summit is critical for demanding Medical, Personal Care and Technical molding applications.

- Superior thermal profile.
- Stainless steel construction.

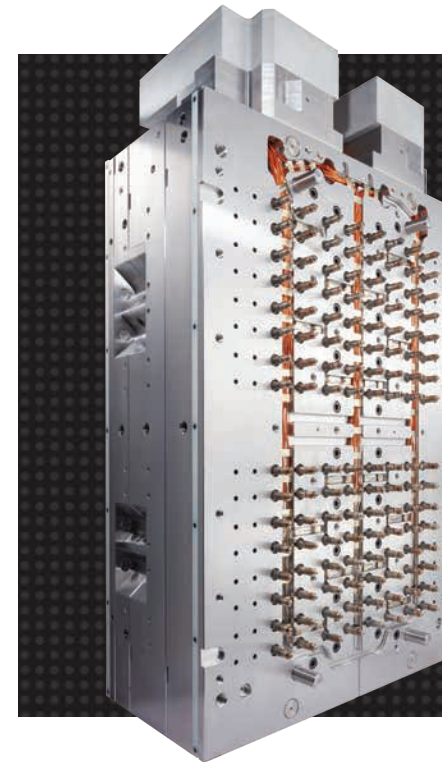
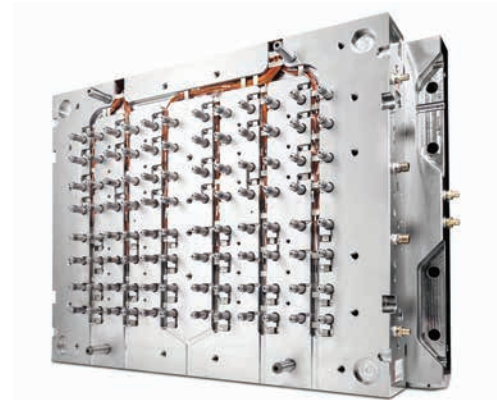

# Master<sup>®</sup> series

## THE BENCHMARK IN HOT RUNNER PERFORMANCE AND RELIABILITY

Proven to deliver consistent high performance processing capabilities for exceptional part quality. Compatible with a wide range of resins, Master-Series is the ideal choice for almost any application across any industry.

- Excellent thermal profile
- Broadest nozzle range
- Advanced capabilities
- Energy efficient

# Accu-Valve<sup>®</sup>

## ACHIEVE THE HIGHEST QUALITY GATES, RELIABLY, FOR MILLIONS OF CYCLES

Precision cylindrical gate component alignment that significantly minimizes wear that leads to gate quality deterioration. Avoid the costly maintenance and downtime associated with traditional valve gate designs. Compatible with both commodity and engineering grade resins, Accu-Valve meets the demanding needs of many Medical, Packaging and Personal Care applications. MX-Enhanced Fill Balance, CX-Color Change, LX-Filled/Abrasive Resins.

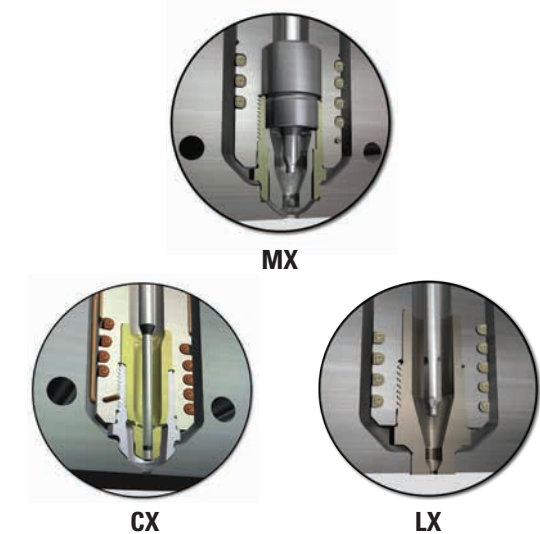

# SIDE GATING

- LOW WEIGHT/DEEP DRAW PARTS • SPECIALIZED PART REQUIREMENTS
- OPTIMIZE GATE LOCATION • OPTIMIZE MOLD LAYOUT • MAXIMIZE PRODUCTIVITY

Mold-Masters continues to support the Medical market by offering a wide range of simultaneous direct side gating solutions of up to 16 cavities per drop. Perfect for high cavitation molds producing deep draw parts, side gating is commonly applicable to many medical components such as pipette tips, syringe barrels, needle shields and more. that. Side gating eliminates scrap from sub-runners and enhances part quality by allowing for optimized gate locations on small parts which can be very difficult or impossible to be produced any other way that would be economical in high volume production. Our compact designs also allow for optimized mold layouts where our customers have the flexibility to lower cost per part by either increasing cavitation or being able to utilize smaller injection machines.

### CONSISTENT HIGHER-QUALITY PRODUCTION

Mold-Masters side gating products benefit from our core technologies (iFLOW/Brazed Heaters) but also incorporate special design technologies of their own. A critical aspect in producing high quality gates is maintaining tip to gate concentricity. Our inline designs feature tips that are located to the gate of the cavity insert so their alignment is not influenced by thermal expansion. Additionally, our specialized dual-gate designs reduces cycle time by up to 50% and provides a more uniform front flow which minimizes "core shift". On pipette tips this improved TIR/deflection tolerances by up to 62%.

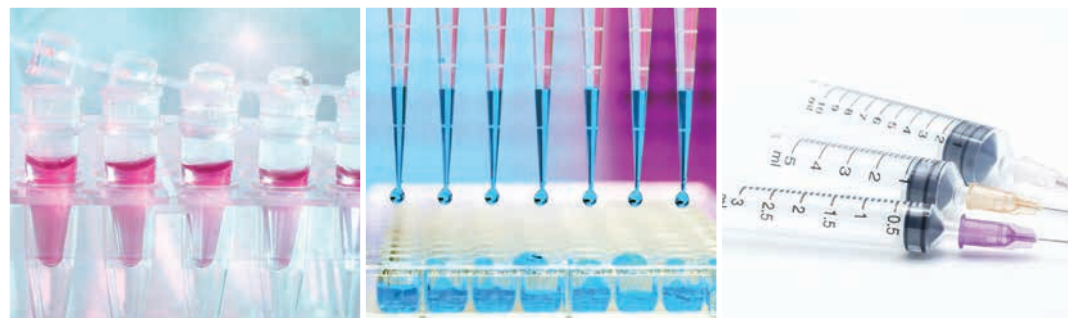
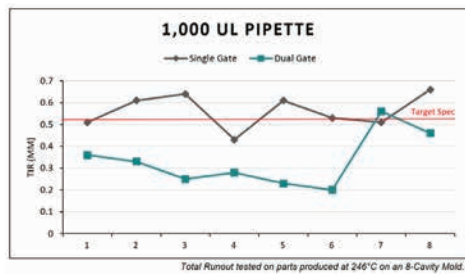
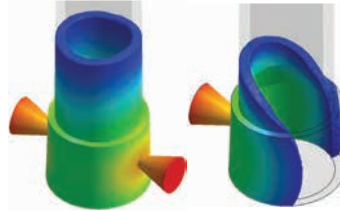

### MAXIMIZING UPTIME

Mold-Masters recognizes that time is money. Our latest Melt-CUBE EVO features the industries simplest inline design that can be serviced with very straightforward maintenance procedures. Only one bolt is required to secure each pair of tips. This allows units to be assembled/disassembled up to 85% faster. On a 64-drop system that saves about 5hrs. How much is that time worth to you?

In addition, all of our side-gating solutions incorporate our reliable Brazed Heater Technology which are eligible for our industry leading 10-year warranty.

### QUICK 4-STEP ASSEMBLY/DISASSEMBLE

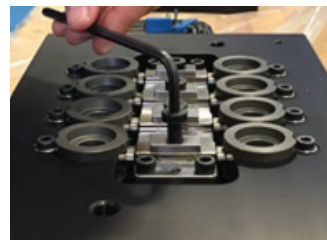

STEP 1 Remove bolt & rectangular washer

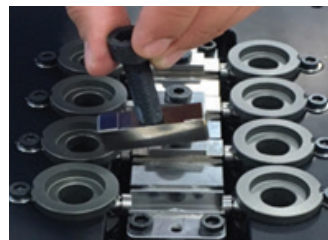

STEP 2 Extract melt block using



STEP 3 Remove and replace tip



STEP 4 Re-assemble

# MeltCUBE EVO



## THE NEXT EVOLUTION IN ADVANCED INLINE SIDE GATING TECHNOLOGY

A newly evolved design that minimizes downtime and enhances processing capabilities. Simultaneous direct side gating solution of up to 8 cavities per Cube eliminates scrap from sub-runners and enhances part quality. Perfect for high cavitation molds producing deep draw Medical parts such as pipette tips, syringe barrels, needle shields and more.



# MeltCUBE

## ADVANCED INLINE SIDE GATING

Our original Melt-CUBE design available with angled tips and specialized dual-gating capabilities. Simultaneous direct side gating solution of up to 16 cavities per Cube eliminates scrap from sub-runners and enhances part quality. Perfect for high cavitation molds producing deep draw Medical parts such as pipette tips, syringe barrels, needle shields and more.



# Melt-Disk®

## INDUSTRY LEADING CIRCULAR SIDE GATING SOLUTION

Simultaneous direct side gating solution of up to 8 cavities per Disk eliminates scrap from sub-runners and enhances part quality. Geared toward circular oriented mold layouts. Perfect for high cavitation molds producing deep draw Medical parts such as pipette tips, syringe barrels, needle shields and more.



# Tit-Edge

## OUR SIMPLEST AND MOST ECONOMICAL SIDE GATE SOLUTION

Simultaneous direct side gating solution of up to 4 cavities per drop. A simplistic design that reduces machining complexity and cost. Ideal for thick wall applications such as large medical syringe barrels, specialty packaging, writing instruments or other similar parts.





# PACKAGING

- HIGH VOLUME PRODUCTION • MAXIMIZE PRODUCTIVITY • FAST COLOR CHANGES
- ROBUST & RELIABLE DESIGNS • LOW COST OF OWNERSHIP

Mold-Masters understands the packaging industry and delivers solutions that supports the needs of our customers. Our packaging hot runner systems are optimized for ultra high speed molding, incorporate industry standard gate cut-outs and are extremely robust. Mold-Masters is the only hot runner supplier to offer an available industry leading 10-year warranty. Mold-Masters has you covered.

### LOWER OPERATIONAL COSTS

Mold-Masters is able to produce parts of the highest quality, however we recognize the importance of controlling operational costs, especially for the packaging industry where margins can be razor thin. To address these market concerns, Mold-Masters ensures our hot runner systems are economical to operate and maintain. While our SPRINT nozzles are lower wattage for improved energy efficiency, Mold-Masters has also eliminated some components that make up significant costs associated with spare parts: nozzle heaters and vestibules.

Mold-Masters hot runner systems offer Brazed Heater Technology that are so reliable they're covered by an available industry leading 10-Year Warranty. Additionally, gating styles for packaging applications are available without vestibules, one of the most significant spare part costs. Vestibules commonly crack or break during production. Eliminating these components also saves on costs associated with downtime and maintenance.

### FAST COLOR CHANGES

Optimized runner channels of Mold-Masters iFLOW Manifold Technology eliminates sharp corners and dead spots to improve color change by up to 45%.

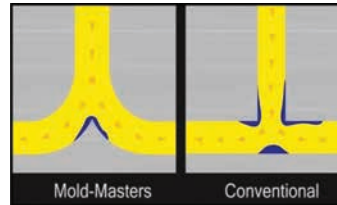

### ENHANCED LEAKAGE PROTECTION

Mold-Masters MasterSHIELD Technology offers enhanced leakage protection between the nozzle and manifold. This robust, patent pending design, maintains a leak proof seal offering reliability even during cold start-ups or in the event of accidental overheating.

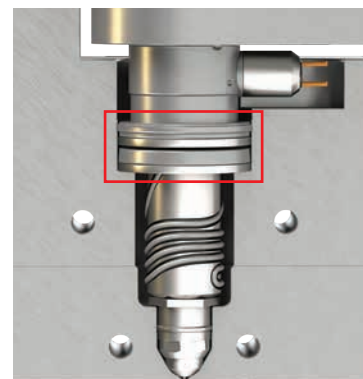

MasterSHIELD Technology



# Sprint™

## LIGHTNING FAST, SPECIALIZED CAP & CLOSURE SYSTEM

Optimized for reliable high speed molding, Sprint systems are capable of <2 second cycle times, fast color changes and low energy consumption. A range of special features ensures highest production quality while minimizing downtime. Now includes MasterSHIELD Technology as standard for enhanced leakage protection. Compatible with PP, PS, HDPE, LDPE and other resins.

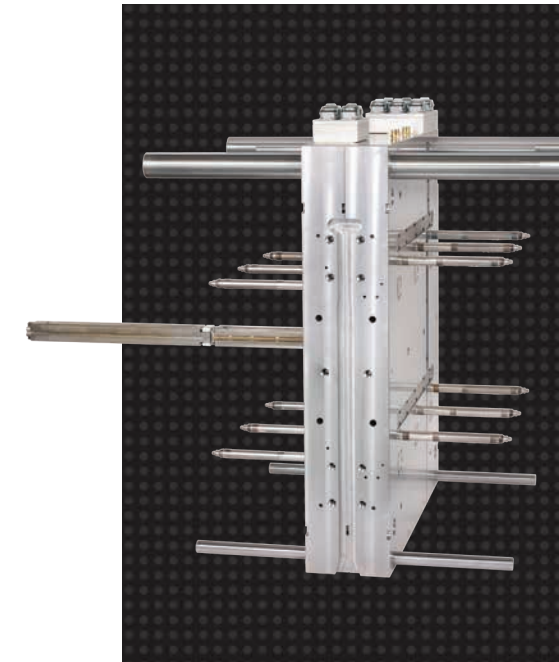

# ThinPAK series

## THE SPECIALIZED SYSTEM FOR HIGH PRESSURE THIN WALL PACKAGING

Introducing the industry's newest hot runner system specifically engineered for producing exceptional high quality thin wall packaging products. Incorporating new MasterSHIELD Technology, ThinPAK-Series has the strength and durability to mold with complete reliability in high pressure applications up to 2,800 Bar. Compatible with PP, PS, PE and other resins.

# CO-INJECTION

## OPTIMIZING PART PERFORMANCE AND COST

Mold-Masters industry leading Co-injection technology allows for two materials to be injected simultaneously, creating a 3-layer structure, in a single step. Incorporate high performance barrier materials to preserve freshness, maintain flavor and extend shelf life of products. Convert mono-layer components to multi-layer without sacrificing existing part quality or productivity levels.



# AUTOMOTIVE

- CLASS "A" FINISHES • HIGHLY TECHNICAL • MAXIMIZE UPTIME • LOW COST OF OWNERSHIP • GLOBAL SUPPORT NETWORK

Mold-Masters understands the automotive industry and delivers solutions that supports the needs of our customers. Our automotive hot runner systems are optimized for delivering exceptional part quality by addressing common technical challenges associated with molding medium to large parts that demand Class "A" surface finishes. In addition, our designs facilitate in field maintenance that is quick and easy which helps to ensure you stay in production longer. Lastly, Mold-Masters Global Support Network has you covered from initial hot runner design and analysis through to production. Our global spare part warehouse facilities are stocked to ensure you receive standard spare parts quickly no matter where you are.

### PRODUCING CLASS "A" SURFACE FINISHES

Molding medium to large parts for the automotive industry comes with its own unique set of technical challenges compared to other industries. Forward thinking automotive designs incorporating challenging resins continue to push the envelope of what's considered possible. However Mold-Masters is always up for the challenge.

Mold-Masters automotive hot runner solutions incorporate a range of features that are designed to accommodate these process variables. For example, uncontrolled resin flow can severely impact part quality which appear as defects such as weld lines and pressure marks. Our advanced SeVG+ (Servo Electric Valve Gate) actuation control system offers complete control over the actuation profile of each individual valve pin. Users can now produce molded parts of exceptional quality that would not otherwise be possible.

### MAXIMIZING UPTIME

Not only are Mold-Masters automotive focused hot runner systems drop-in ready, but our designs are easily serviced in the field, often without the need for special tools. Many of our hot runner systems and various controllers incorporate special features that speed up set-up, start-up, shut-down and maintenance.

For example, FusionG2 now offers Waterless Actuators that incorporate Passive Actuator Cooling Technology (PACT). These advanced, patent pending actuator designs eliminate conventional hose plumbed cooling circuits.

### GLOBAL SUPPORT NETWORK

Mold-Masters is dedicated to providing industry leading support to meet the unique needs of our automotive customers. We are dedicated to helping ensure their projects are successful even under the most challenging conditions. This support is offered through the entire lifecycle process from design concept through to full scale production. Mold-Masters also operates strategic spare part facilities and offers remote technical support as a first response to minimize lead times and to resolve any issue that may arise as quickly as possible.



Lighting



Exterior



Interior



Under Hood



## Fusion<sup>®</sup> G2 series

### DROP IN, CONNECT AND INJECT

A completely pre-assembled and pre-wired system which allows for quick and easy one step drop in installation and connection. Ensures your mold gets into production as quickly as possible while incorporating a wide range of specialized features that maximize uptime. These include nozzles that can be installed in cold conditions, waterless actuators and quick release/adjustable actuators. FusionG2 nozzles have a shot range of <15g-5,000g+ and are available with compact nozzle bore cut-outs as small as Ø20mm to minimize machining requirements and improve gate access on smaller/technical parts.

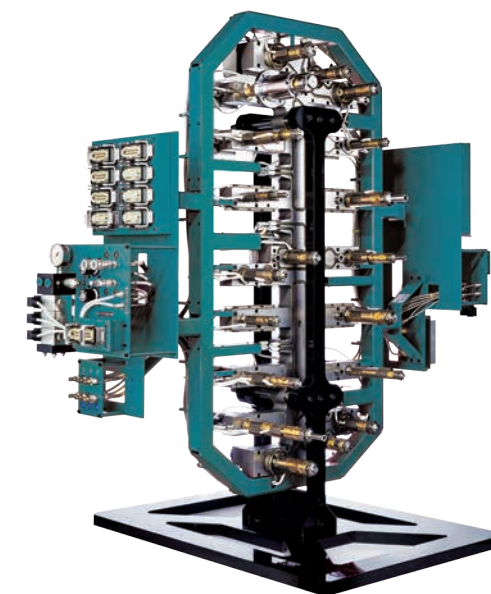

## Dura<sup>®</sup> PLUS

### THE CLEAR CHOICE FOR LENSES

The ideal hot runner system for consistent, high quality production of automotive lens components that demand exceptional clarity. Engineered to perform with today's challenging resins it is compatible with corrosive resins such as PC, PC-ABS & PMMA. Dura+ remains the clearest choice for automotive lens molding applications.

## Accu-Line<sup>™</sup> FM

### EASY, ECONOMICAL SINGLE CAVITY VALVE GATING

Engineered to deliver exceptional part quality with today's challenging abrasive, corrosive, shear and temperature sensitive resins such as PC, PC-ABS, POM & PMMA. Critical for demanding Automotive Lens, Medical, Personal Care and Technical molding applications.



## TECHNICAL/SPECIALTY

- COMPLEX PART GEOMETRIES • SMALL LIGHTWEIGHT PARTS
- CHALLENGING GATE LOCATIONS • HIGH QUALITY PRODUCTION

Mold-Masters broad product portfolio includes industry-leading solutions for a variety of technical applications. Technical applications often demand specialty solutions. This includes solutions for applications requiring tight gate access, compact mold designs, reduced stack heights, increased productivity, processing new materials and much more. If you have an application and interested to see what solutions are available to you, be sure to speak to Mold-Masters today. If we don't already have something on hand, we have the ability to create a customized solution that works. Mold-Masters allows our customers to do more.

### SPECIALTY SOLUTIONS

Technical applications often demand specialty solutions. Mold-Masters engineers have a broad range of proven solutions to choose from that minimizes risk and gives our customers the best chance of success. We can accommodate a variety of applications including those with complex geometries, tight pitches, limited gate access and more. For example, our Master-Series FemtoLite nozzles (our most compact) can be utilized in a variety of configurations and are ideal for tight pitch and inside gating applications.



On applications where our existing solutions aren't ideal, Mold-Masters MasterSOLUTIONS Team is available to tackle your toughest challenges. They have the ability to modify our existing designs or create something completely new that's optimized to perform to our high standards.

On applications where our existing solutions aren't ideal, Mold-Masters MasterSOLUTIONS Team is available to tackle your toughest challenges. They have the ability to modify our existing designs or create something completely new that's optimized to perform to our high standards.

### ENABLING BROADER UTILIZATION

In addition to part quality considerations, Mold-Masters technology allows for broader mold utilization. Mold-Masters hot runner systems with iFLOW Manifold Technology can be manufactured with thinner profiles which allows stack heights to be reduced by up to 22% compared to traditional gun-drilled manifolds. This allows the mold to be operated on machines with lower tonnage (existing or even smaller machines).

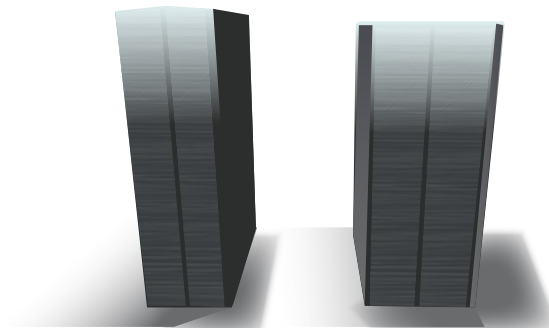

Mold-Masters iFLOW Manifold Technology offers compact stack heights



Mold-Masters Multi-tip Nozzles



## Master<sup>®</sup> series Femto-Lite™

### OUR SMALLEST, MOST COMPACT NOZZLE

Our most compact Master-Series nozzle solution, for highest quality molding of small parts, with advanced capabilities for tight pitch or inside gating. Available valved or non-valved. Ideal for many medical, personal care, packaging and small closure applications. Compatible with a wide range of resins.

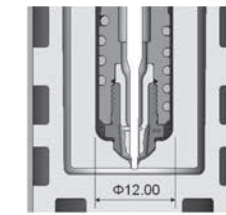

## Slim-Stack

### REDUCE STACK HEIGHT BY UP TO 40%

Introducing the industries most compact stack mold center section assembly. Available as an option on Master-Series Stack Mold Hot Runner systems, it is especially valuable on projects with stack height limitations. This advanced design incorporates inline actuators affixed to a single common manifold. Ideal for many Packaging, Personal Care, Medical and Caps and Closure applications.

## LSR Cold Deck

### INDUSTRY LEADING LSR PROCESSING CAPABILITIES FROM KIPE

Now get valve gated cold decks for precision LSR molding from Mold-Masters through our exclusive strategic partnership with KIPE MOLDS. KIPE brings over 40 years of highly successful LSR knowledge and experience to our customers. Your best solution for optimized processing of LSR in single shot or over molding applications across any industry.

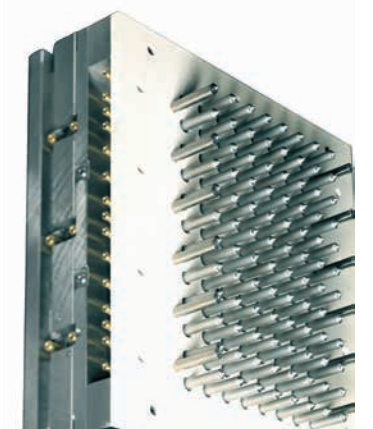

# PET

- HIGH QUALITY PRODUCTION • MINIMIZE SCRAP • LOW COST OF OWNERSHIP
- PREVENT DOWNTIME • GLOBAL SUPPORT NETWORK

Mold-Masters understands the PET industry and delivers industry-leading solutions that supports the needs of our customers. Our high-performance single and 2-stage hot runner systems are optimized for delivering exceptional molded part quality and focused on increasing productivity and minimizing downtime to help achieve the lowest cost-per-part possible. We also offer our customers the flexibility to work with the machine and robotics supplier of their choice. In addition, Mold-Masters Global Support Network has you covered from initial hot runner design and analysis through to production. Experienced and knowledgeable Mold-Masters designers have the capability to add value by helping to identify light weighting opportunities and enhancing packaging designs.

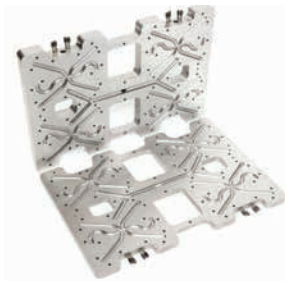

### ENHANCE PRODUCTION QUALITY

Mold-Masters PET hot runner systems are engineered to maximize performance and produce higher quality molded parts. Optimizing process and injection speed enhances quality, especially in the neck area.

We also offer flexibility in preform

design that provide opportunities for light weighting. Our hot runner systems are available with iFLOW Manifold Technology that feature patented melt flow geometry, flow path options and runner shapes. By eliminating sharp corners and dead spots, iFLOW offers best in-class melt management and industry-leading mold fill balance. The results are faster fill times, lower fill pressure, reduced AA levels and wider process windows (especially on older machines).

### MAXIMIZING UPTIME

Mold-Masters understands that productivity is just as important as part quality. In support of this, our R&D department has introduced several key innovative technologies. MasterSHIELD Technology offers enhanced leakage protection between the nozzle and manifold. This robust, patent pending design, maintains a leak proof seal offering reliability even during cold start-ups or in the event of accidental overheating.



### COMPLETE FLEXIBILITY

As a company, Mold-Masters is focused on hot runners. This means our customers have complete flexibility to work with the mold and machine suppliers of their choice.



# Axiom

## FULLY BALANCED IN-LINE SINGLE STAGE PET VALVE GATED HOT RUNNER SYSTEM

1-40 drop hot half systems designed for injection blow systems (IBS) and injection stretch blow machines (ISBM). Specifically engineered to meet the requirements of the competitive PET bottle manufacturing industry, Axiom is focused on enhancing part quality, increasing yield and lowering production costs.

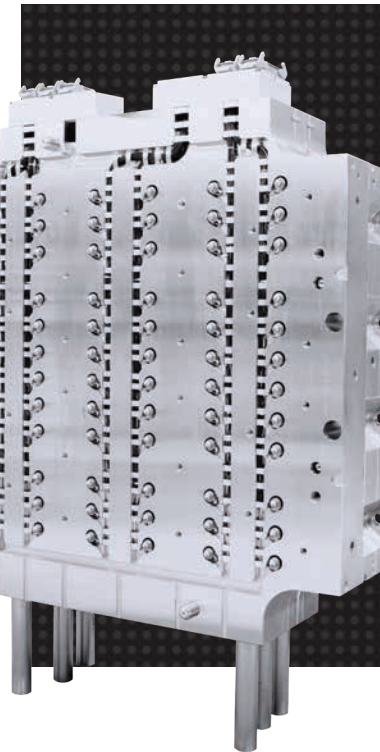

# PET series

## THE SPECIALIZED HOT RUNNER SYSTEM FOR PRODUCING 2-STAGE PET PREFORMS

Our latest generation design incorporates a variety of cutting-edge innovative technology that carries the PET industry into a new era. This includes MasterSHIELD Technology for enhanced leakage protection even in cold conditions. Molders can expect to achieve lower part costs through enhanced part quality and increased productivity. PET-Series is compatible with many industry standard layouts, existing molds and all major machine platforms including those with post-mold technology.

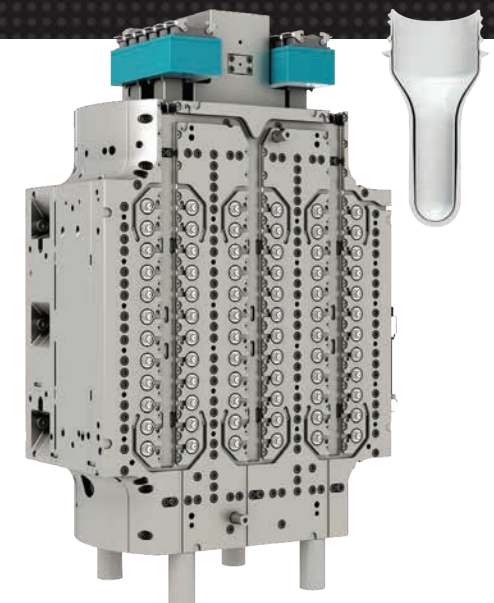

# CO-INJECTION

## OPTIMIZING PART PERFORMANCE AND COST

Our industry-leading Co-injection Technology utilizes a proprietary nozzle design that allows for two different resins to be combined into a single 3-layer melt stream. Enhance packaging performance to extend product shelf life (maintaining freshness and flavour) by incorporating a high-performance moisture, gas or light barrier as the core layer. Reduce part costs by minimizing expensive barrier/colorant materials and eliminating secondary operations. Convert mono-layer components to co-injection multi-layer without sacrificing current part quality or productivity levels.

# VALVE GATE ACTUATION CONTROL

Hot runner systems can be offered with or without valve gates, however valve gating brings with it a range of advantages. This includes a wider processing window, the ability to produce larger parts, the ability to process larger shot weights and enhanced product and gate quality. The choice to utilize a valve gate design may or may not be in your control depending on your application. Valve gating brings with it additional process complexity and challenges. It is important to understand what options are available to help deliver the results you desire.

## CONVENTIONAL ACTUATION

Valve pin actuators are common in many hot runner applications and their movements are typically powered by either Pneumatic Air or Hydraulic Oil. While sufficient for many applications they have their limitations. On their own, the movements of these conventional actuators are restricted to simply opening or closing. While they generally actuate at the same time, there is some variability from drop-to-drop and from shot-to-shot. This is most commonly found with high cavitation Pneumatic systems where not all actuators are able to move at the same time. This variability can affect mold balance and overall part quality.

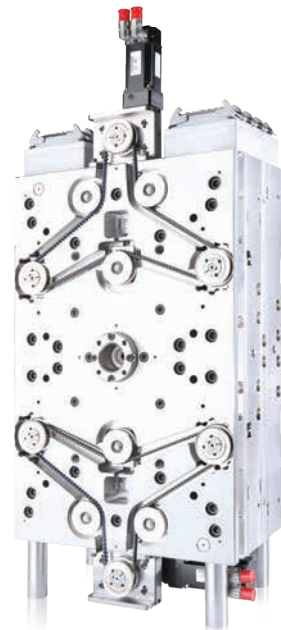

E-Drive synchro plate system

## MINIMIZING ACTUATION VARIABILITY

In order to overcome the limitations of conventional actuation methods, there are several more advanced options that are available. Choosing the right solution, again, depends on the application however Mold-Masters full range of options means we have you covered. Actuation control systems are available in pneumatic, hydraulic and electric.

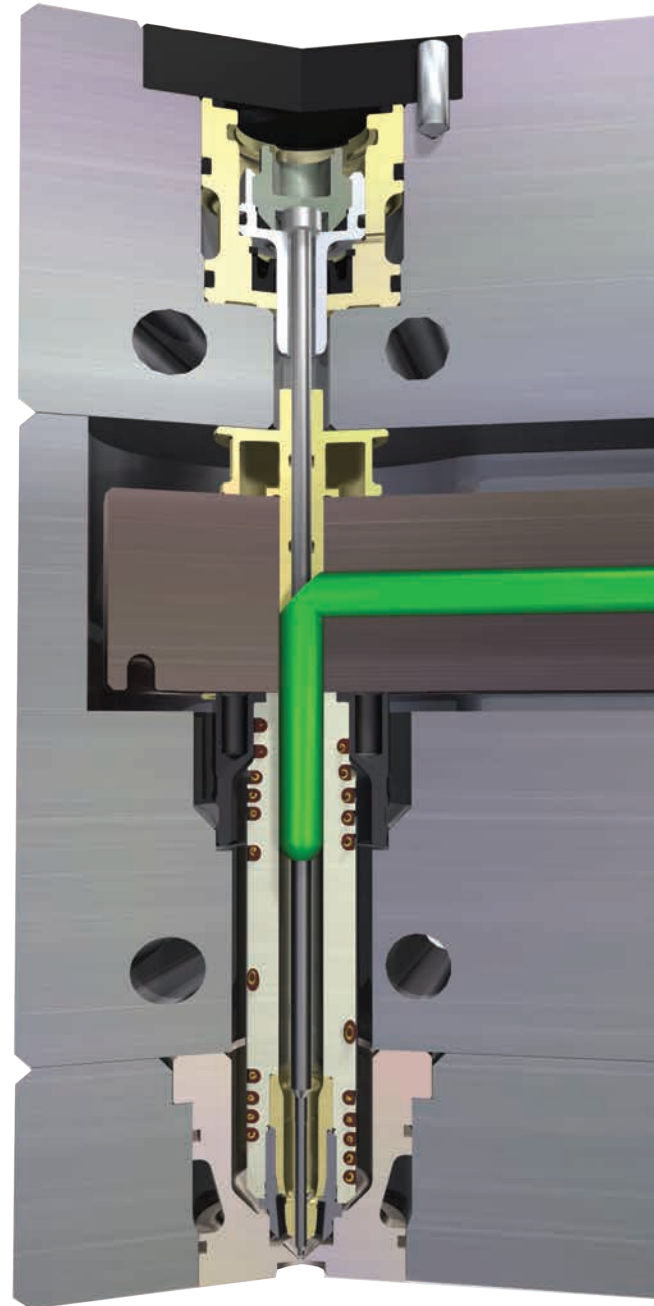

# E-Drive™

## SERVO DRIVEN SYNCHRO PLATE SYSTEM ELIMINATES ACTUATION VARIABILITY

Simultaneous valve pin motion control of up to 144 cavities with precise 0.01mm tolerances for exceptional process control. Easily adjust pin stroke, velocity, torque, timing and position to improve mold balance and production quality. Compatible with all resins,

E-Drive is ideal for tight tolerance and tight pitch applications across a wide range of industries. Electric drive is suitable for clean room applications. Synchro plates are also available in Pneumatic and Hydraulic formats.

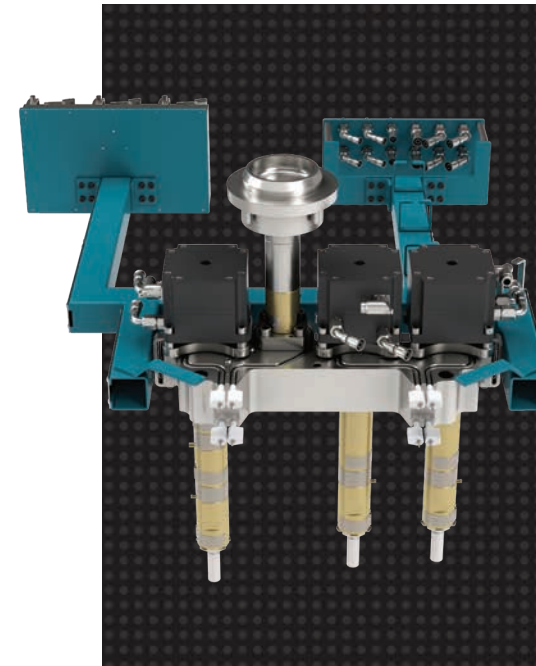
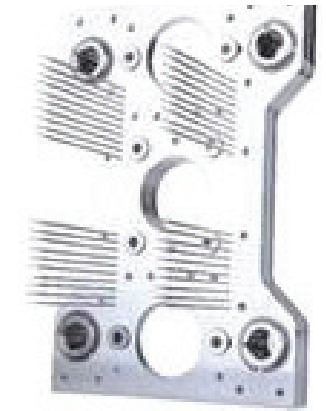

# SeVG® PLUS

## SERVO ELECTRIC VALVE GATE

Our most advanced actuation control system. A servo driven system that provides absolute control and precision over individual valve pin opening and closing actuation profiles. Fully adjust pin position, acceleration, velocity, stroke, timing and sequence. Critical capabilities that greatly enhances molded part quality for demanding applications. Available for all applications including large automotive parts that require Class "A" surface finishes.

# SVG

## SEQUENTIAL VALVE GATE CONTROL

Enhanced control of valve gate flow sequence and timing for pneumatic or hydraulic systems. Improve mold balance and part quality. Essential control when molding complex or large parts.



# UNLOCK YOUR OPERATIONS FULL POTENTIAL

TempMaster controllers are the industry's most precise and reliable hot runner temperature control platform. With one of the most comprehensive product lines on the market, we have the solution that's right for your application and your budget. Optimize the performance of any hot runner system and unlock your operations full potential with TempMaster.

### PRECISE APS CONTROL TECHNOLOGY

All TempMaster controllers feature APS (Adaptive Process System) technology. APS is the industry's leading heat control algorithm that ensures precise temperature control is maintained. APS continuously monitors, learns, predicts and automatically adapts to process variables. Making almost instantaneous micro adjustments ensures mold temperatures are maintained with the highest degree of precision.

### HIGH CAPACITY MODULAR CONTROL CARDS

APowering every TempMaster controller is our advanced M-Series cards. Their high capacity design reduces your card requirements by up to 60% vs competitive alternatives and are available with the widest selection from 5A to 40A which allows you to optimize power requirements to your application. Cards can be accessed in seconds, which contain on-board heater and thermocouple fuses, so servicing is quick and easy. M-Series cards feature the latest technology and innovations that deliver the performance, power and reliability that molders rely on.

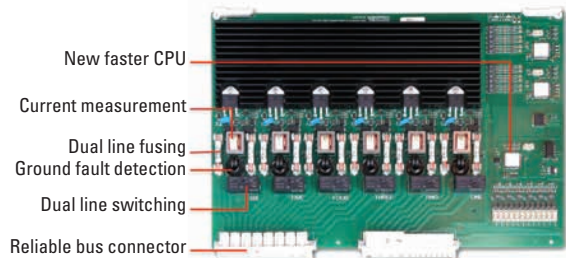

### CLASS LEADING COMPACT DIMENSIONS

TempMaster controllers feature some of the industry's most compact cabinet dimensions in their class. This preserves a significant amount of valuable floor space and makes units easier to handle.

Our flagship TempMaster M2+ cabinet has a footprint up to 53% smaller (57% overall) than competitive systems of equal functionality and number of zones.

### INTUITIVE TOUCH SCREEN CONTROLS

Full color touch screen HMI's come standard with all TempMaster controllers that makes information easy to identify and quick to differentiate. Our systems Intuitive layout means our controllers can be used with minimal training and allow you to get back into production almost immediately.

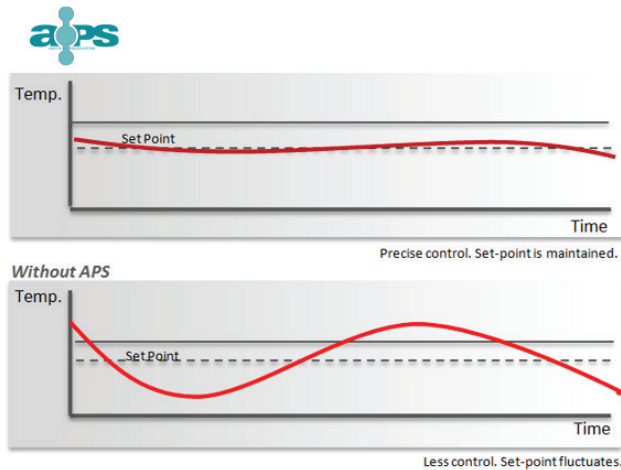

## TempMaster™ series M3

### REVOLUTIONIZE YOUR OPERATION. ELIMINATE CONVENTIONAL TC MOLD CABLES

Introducing our NEW TempMaster M3 controller platform which incorporates many new exciting innovations including revolutionary TC-Connect Technology and APS-AI. These technologies will simplify your molding cell, save you money and improve your process capabilities.

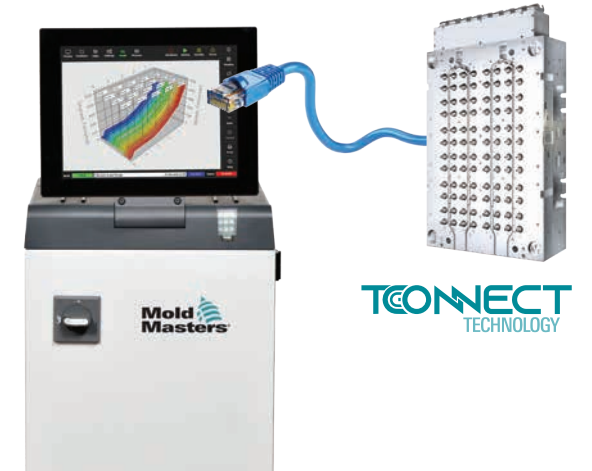

## TempMaster™ series M2+

### ADVANCED, FULLY FEATURED CONTROL FOR SUPERIOR MOLDING PERFORMANCE

The M2+ offers the industries most advanced control features and functions. Designed with flexibility in mind, M2+ performs to the highest standards in any molding application with any resin while remaining simple and intuitive to operate.



## TempMaster™ series M1+

### ADVANCED, COMPACT TEMPERATURE CONTROL FOR MEDIUM SIZED MOLDS

The M1 platform combines popular features with advanced APS Technology for precision control of up to 48 zones. Powerful performance in a compact unit.



## TempMaster™ series Me

### OUR SIMPLEST AND MOST ECONOMICAL TEMPERATURE CONTROLLER.

The Me platform combines essential features with advanced APS Technology for precision control of up to 12 zones. Powerful performance from a compact unit that helps improve part quality and minimize scrap.



# PROCESS SYSTEMS

- HIGH QUALITY PRODUCTION • INCREASED PROCESS STABILITY
- MINIMIZE VARIABILITY • ENHANCED CONTROL • IMPROVED REPORTING

There are many processing variables that play a factor in molding parts of acceptable quality, including those that go beyond the hot runner system itself. Some of those variables include Mold Cooling and Automated Mold Functions. Mold-Masters offers critical systems to help minimize such variables in order to produce higher quality parts, more consistency from drop to drop and cycle to cycle day in and day out. After all, at the end of the day, it's the good parts in the box that matters.

## A COMMON CHALLENGE

When it comes to molding with a validated processes, it is not what the machine is told to that is important, it is what the machine is actually doing that matters. Although a process may be fully validated it is often impossible to confirm whether the process is actually running at these settings. In terms of mold cooling for example, there may be a partial blockage in a water circuit or even an incorrectly piped mold. In a variety of circumstances, its possible for the temperature controller to still show the coolant at the correct temperature when the reality is quite different.

Even though the mold temperature is an important control characteristic, many do not have the proper systems in place to verify their setting. Mold-Masters process systems overcomes these limitations and provides increased confidence and reliability in the process.

Automated mold functions are another important consideration that can impact productivity. The cycle time of a hot runner system can only be optimized to go as fast as the slowest piece of equipment within a molding cell.

Mold-Masters M-Ax Motion Controller gives customers the ability to cycle molds with rapid and precise movements for exceptional repeatability. This is critical for many of today's modern mold designs and essential for increasing productivity while minimizing risk of equipment damage.



# TempMaster™ WFM series

## WATER FLOW MONITORING SYSTEM

Coolant flow and temperature are often critical factors in achieving consistent production of quality molded parts and faster cycle times. Monitoring individual cooling circuits with WFM, compared with traditional flow regulators, offers molders an advanced solution that achieves greater process accuracy and confidence. Available as a standalone system or integrated with our TempMaster M2+ hot runner temperature controller.



## PRECISION CONTROL FOR SERVO DRIVEN AUTOMATED MOLD FUNCTIONS

Molding environments are increasingly being digitized. Servos for mold functions offer superior precision, control and repeatability over traditional methods. The M-Ax servo motion axis controller offers the greatest process control accuracy and easiest adjustments of automated linear and rotary mold functions.

### SERVO FUNCTIONS

#### Standard

- Valve gates.
- Core pulls.
- Coining plates.
- Index plates.
- Stripper plates.
- Ejector plates.
- Rotary tables.
- Spin stack.

#### Advanced

- E-Drive.
- E-Multi.
- And more...





**OPEN THE DOOR TO PRECISION MULTI-SHOT APPLICATIONS**

Easily and economically convert any existing injection molding machine to allow multi-shot capabilities with the E-Multi Auxiliary Injection Unit. The successful E-Multi platform offers proven precision, repeatability, versatility and reliability. Compatible with a wide range of thermoplastic and LSR materials, E-Multi is ideal for a wide range of application across any industry.

**PRECISION SHOT CONTROL**

Precision is a critical component of molded part quality and helps minimize scrap. E-Multi servos drive barrel screws whose position can be controlled to within 0.01mm. This shot volume control on smaller E-Multi units means that shot weight can be managed to a weight variation of as little as 0.004g with complete repeatability and accuracy.

**COMPACT SIZE**

E-Multi's compact dimensions and all electric operation save an incredible amount of valuable floor space. In a horizontally mounted configuration, it can operate in areas as little as 1.5m<sup>2</sup> (16ft<sup>2</sup>) which is up to 9.3m<sup>2</sup> (100ft<sup>2</sup>) less than other systems. In a vertically mounted configuration, this space requirement is almost completely eliminated altogether.



**INDUSTRIES WIDEST SELECTION**

There are over 2,000 possible standard configurations for E-Multi units. Choose from various servos, screws, nozzles and many other options. This ensures the unit you receive is perfectly suited to your application and your production requirements.



**THE MOST VERSATILE, ALL ELECTRIC SERVO DRIVEN, AUXILIARY INJECTION UNIT**

**KEY FEATURES**

**SERVO DRIVEN**

- High precision, fast, repeatable and reliable performance.
- Suitable for high tolerance applications.
- Program up to 10 injection profiles and holding pressures.
- Statistical process and production tracking.

**VERSATILE MOUNTING OPTIONS**

- Vertical, horizontal and custom mounting options.
- Can adapt to many requirements.
- Various feeding options available.

**COMPACT DESIGN**

- Preserves valuable floor space.
- Save up to 100ft<sup>2</sup> (9.3m<sup>2</sup>) of space compared to alternatives.
- Vertical installations virtually eliminate any footprint.

**UNIVERSAL COMPATIBILITY**

- Can be installed on ANY Injection Molding Machine.
- Seamless operation via IMM interface.
- Integrate robotic interface.

**ALL ELECTRIC**

- Energy efficient.
- Viable for clean room applications.
- Minimal maintenance requirements.

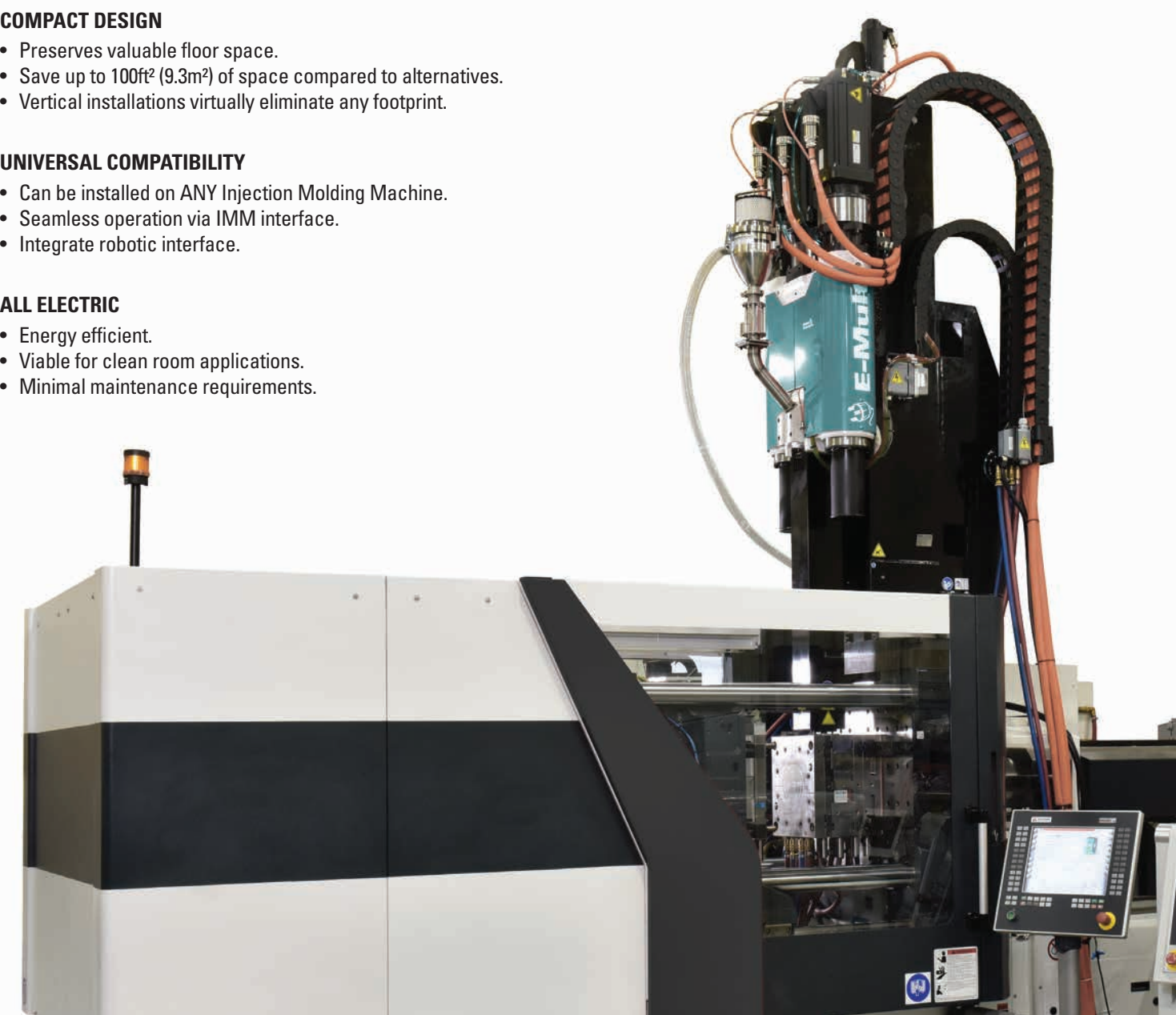



# CO-INJECTION

## IMPROVING EVERYDAY PRODUCTS

Mold-Masters Co-injection, formerly KORTEC®, allows two different resins to be combined into a single 3-layer melt stream consisting of skin and core layers. This specialized process can be used to enhance part performance and cost without any penalty to cycle time or production volume. Depending on the materials selected and the application, Co-injection can be used to extend shelf life, improve production efficiencies and allow for greater design flexibility. The Technology is compatible with High Performance Barriers, Bio-Resins and PCR/Scrap. Mold-Masters Co-injection can be used for a wide range of applications across any industry including preforms, thin wall containers, closures and much more. As the Co-injection Technology Pioneer and industry leader, the world's leading brands trust Mold-Masters.

### THE BENEFITS OF CO-INJECTION

Mold-Masters Co-injection Technology adds value to many of the products we use every day. On food, beverage and medical containers that benefit from utilizing high performance barriers, Co-injection preserves freshness, maintains flavor and extends shelf life of products. Co-injection can also lower production costs of multi-material products by eliminating additional production steps and offers greater design flexibility. Mold-Masters Co-injection is also compatible with Bio-Resin materials.

In other applications, Mold-Masters Co-Injection Technology can also be used as part of a sustainability strategy. It's possible to inject recycled (PCR) or regrind materials as the Core Layer of up to 50% of total part weight. Virgin Material is injected as the Outer Skin Layer to maintain high part quality finish.

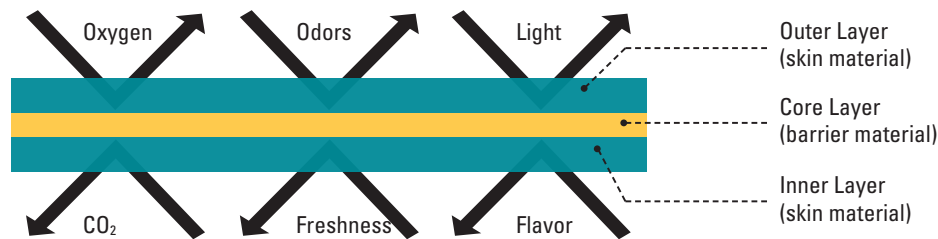

### PRECISE PROCESS CONTROL

As the pioneer and industry leader in Co-injection Technology, Mold-Masters has extensive co-injection science knowledge and the most application experience. We hold many critical process patents to ensure application success. For example, Mold-Masters Co-injection Fold Over Control prevents core layer breakthrough and our Leading Edge Flatness Control maintains barrier consistency even on non-symmetrical shapes and designs.

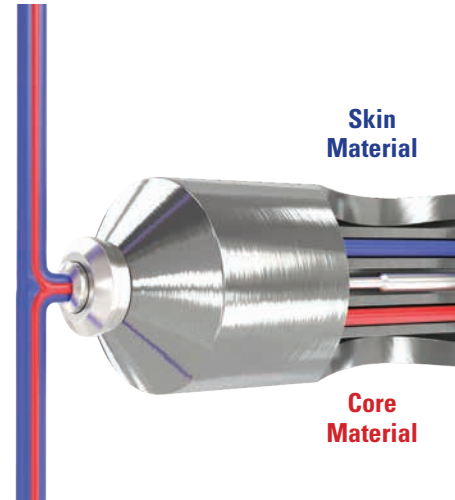

# CO-INJECTION CONNECT

## MOLD HIGHER QUALITY, ECONOMICAL CO-INJECTED PARTS FOR LESS

The Mold-Masters Co-Injection CONNECT solution includes everything you need to easily and economically convert your existing single shot injection molding equipment over to produce co-injected parts.

### KEY FEATURES

#### HIGHLY ECONOMICAL

- Reduce your capital investment requirements by up to 84%.

#### COMPLETE PROJECT FLEXIBILITY

- Work with any machine or mold supplier.
- Customers have complete freedom to choose.

#### HIGH PRODUCTIVITY

- Same output and scale as monolayer parts.
- No cycle time penalty.
- Eliminate secondary processes and scrap.

#### CONNECT PACKAGE INCLUDES:

- Mold-Masters Co-Injection Hot Half.
- E-Multi Co-Injection Auxiliary Injection Unit.
- E-Multi Controller w 15" Touch Screen.
- Engineering.
- Testing Validation.
- Start-up Support.
- Training.

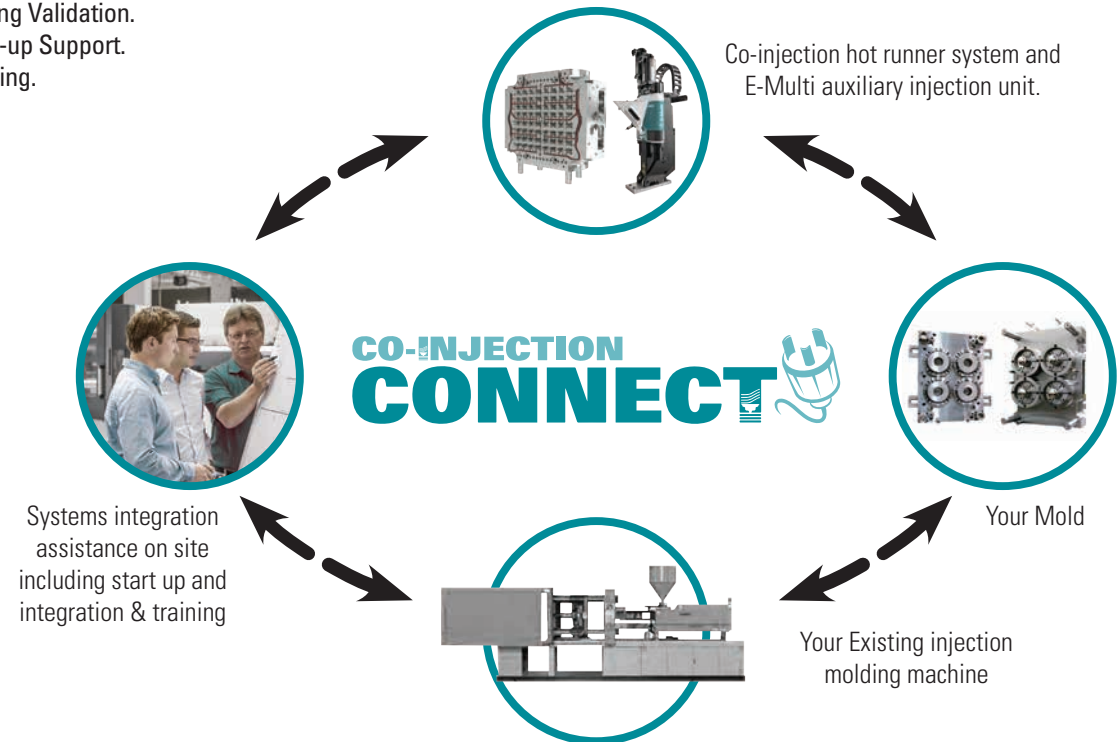
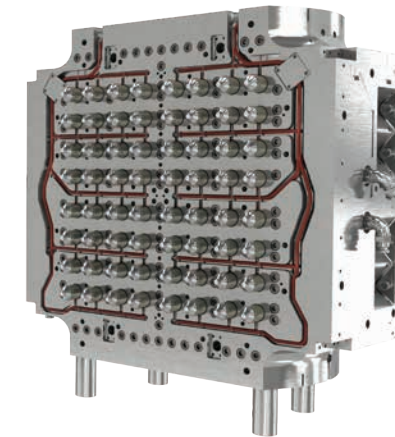

# SmartMold

## MOLD MONITORING SYSTEM

- REAL-TIME DATA • MAINTENANCE TRACKING • DOWNTIME/SCRAP TRACKING • DOCUMENT STORAGE • REPORTING • ALERTS

Mold-Masters SmartMOLD is a cloud-based software platform dedicated to the plastics industry providing real-time data to drive injection molding innovation. Process data is collected from sensors embedded within the injection mold which offers feedback and insights that drive enhanced productivity. Our solution is the first step towards predictive and autonomous capabilities within your facility.

Although SmartMOLD is focused on the mold, it also has the potential to pull data from injection molding machines. SmartMOLD is compatible with any brand of equipment.

### POWERED BY THE CLOUD

- Real time data.
- Accessible 24/7 with reporting and analytics.
- Ensures you always have the latest version (no manual updates required).
- Does not require customers to have their own IT team in order to support.
- Enables the path to predictive and other powerful capabilities.

### DATA SYSTEM INTEGRATION

- Pull data into existing ERP/MES systems.
- API's available for any system.
- Export data in various formats (Excel, csv, xml, net, etc.).

### FLEXIBLE & ECONOMICAL

- Compatible with any brand of mold and/or machine.
- Connect molds only, injection machines only or connect everything.
- Users can scale the system to their facility and budget requirements
- Only pay for what you use.

### A GLOBAL SOLUTION

- Server facilities operating in several major regions.
- Compliance with local data privacy laws.
- Enhances data response times.
- Unlimited data storage.
- Global installation and technical support.

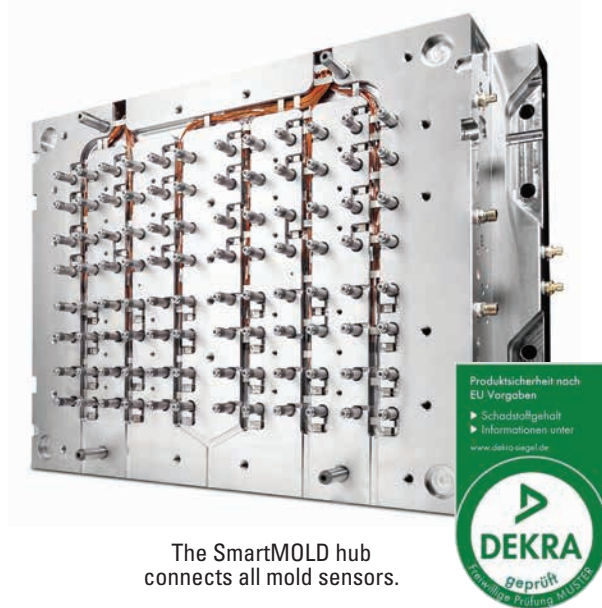

The SmartMOLD hub connects all mold sensors.

# SmartMold

## NEW MODERN AND INTUITIVE USER INTERFACE

SmartMOLD features a new look and feel. Information can be viewed from the highest level or drilled down to the smallest detail. Data is presented in a simple to understand format while navigation is quick and easy.

### MULTI-PLANT OVERVIEW

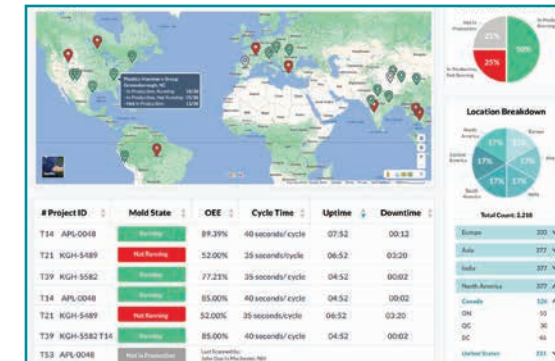

See critical details of your facilities and molds from a global perspective. Filters allows users to focus on certain projects/regions.

### INDIVIDUAL VIEW



Compare productivity shift to shift. Track downtime and scrap.

### ANALYTICS & REPORTING



Visual charts makes information easy to digest. Reports can be pulled on almost anything and scheduled to be run at regular intervals.

### PLANT PRODUCTION OVERVIEW



A simple high-level view with icons to quickly identify issues.

### MAINTENANCE SCHEDULE & HISTORY

TASK	INTERVAL	PROGRESS	REMAINING	DATE DUE	COMPLETED
Service A	10,000	27%	2,700	6/25/2021	
Service B	20,000	100%	20,000	DUE TODAY	✓
Service C	30,000	0%	-5 days	5/31/2021	

Ensure proper maintenance guidelines are followed and track what's been completed.

### MOBILE APP & QR CODE ID TAGS



View production status and enter data on the go. Quickly identify and pull up equipment information. Set email/sms alerts on almost anything.



## GLOBAL CONTACTS

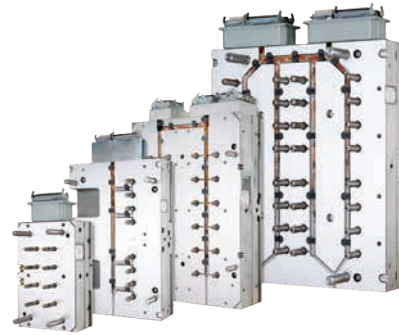

### NORTH AMERICA

#### CANADA (Global HQ)

tel: +1 905 877 0185  
e: canada@moldmasters.com

#### U.S.A.

tel: +1 248 544 5710  
e: usa@moldmasters.com

### SOUTH AMERICA

#### BRAZIL (Regional HQ)

tel: +55 19 3518 4040  
e: brazil@moldmasters.com

#### MEXICO

tel: +52 442 713 5661 (sales)  
e: mexico@moldmasters.com

### EUROPE

#### GERMANY (Regional HQ)

tel: +49 7221 50990  
e: germany@moldmasters.com

#### UNITED KINGDOM

tel: +44 1432 265768  
e: uk@moldmasters.com

#### AUSTRIA

tel: +43 7582 51877  
e: austria@moldmasters.com

#### SPAIN

tel: +34 93 575 41 29  
e: spain@moldmasters.com

#### POLAND

tel: +48 669 180 888 (sales)  
e: poland@moldmasters.com

#### CZECH REPUBLIC

tel: +420 571 619 017  
e: czech@moldmasters.com

#### FRANCE

tel: +33 (0)1 78 05 40 20  
e: france@moldmasters.com

#### TURKEY

Tel: +90 216 577 32 44  
e: turkey@moldmasters.com

#### ITALY

tel: +39 049 501 99 55  
e: italy@moldmasters.com

#### AUSTRALIA

tel: +65 83398887  
e: australia@moldmasters.com

#### NEW ZEALAND

tel: +65 83398887  
e: newzealand@moldmasters.com

### ASIA

#### CHINA (Regional HQ)

tel: +86 512 86162882  
e: china@moldmasters.com

#### KOREA

tel: +82 31 431 4756  
e: korea@moldmasters.com

#### SINGAPORE\*

tel: +65 6261 7793  
e: singapore@moldmasters.com

\*Coverage includes Southeast Asia,  
Australia and New Zealand.

#### JAPAN

tel: +81 44 986 2101  
e: japan@moldmasters.com

### INDIA

#### INDIA (Regional HQ)

tel: +9 422 423 4888  
e: india@moldmasters.com