



COOLCAP®-ARBORS

For efficient chip removal and cooling

COOLCAP®

Cutter and cooling-medium optimized cooling

COOLCAP® arbors from POKOLM are considered the most optimal system for effective cooling. Because with COOLCAP® arbors the flow rate of cooling media and the exit velocity are optimally distributed on the cutter with different diameters and adapted to the different cooling media. Effective direct cooling enables higher machining parameters, and chips are reliably removed from the cutting zone.

The best possible lubrication in the cutting zone is guaranteed, in addition, a high surface quality too. This is how your milling process simply becomes faster, more efficient and safer - indispensable presupposition for an optimized cutting result.

Excellent attributes at a glance

- Flow rate and exit velocity are ideally matched for the different cutter diameters
- Different COOLCAP® caps, designed for the different cooling media air / MQL or emulsion / cooling water
- Ring-shaped cooling jet for optimum cooling results and the chips removal
- The targeted airstream reduces consumption of the compressed air and at the same time increases the effectiveness
- Increased cutter tool life
- Due to the low mass of the cap (less than 30 grams), the high balancing quality of the recording is not affected
- Caps can be easily, fast and inexpensive replaced if needed, without any influence on the arbor usability
- Due to the subsequent installation of the cap, shrinking process is not obstructed
- Sealed without sensitive sealing ring or other type of sealant
- The annular gap reduces the risk of clogging by particles
- Easy installation using the application tool
- Increased process reliability when using Indexable insert tools in conjunction with extensions by removing the chips from the cutting area

COOLCAP®-operating principle

Replaceable COOLCAP®-caps, perfectly matched to the various cooling media, are a decisive factor for achieving excellent milling performance.



COOLCAP® for emulsions guarantee the highest possible plus a targeted volume flow, which effectively removes chips from the cutting zone even with large tools.



On top of that, with its extremely small discharge aperture, COOLCAP® for air-cooling and MQL reduces the use of expensive compressed air.

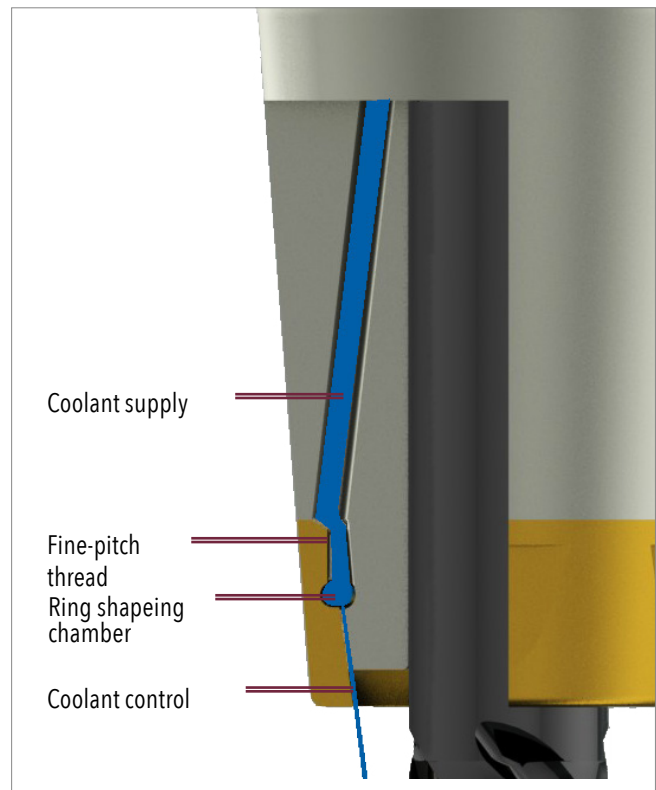

Practical-Video
COOLCAP®

More Produkt-Videos available on:
youtube.com/pokolmknowhow

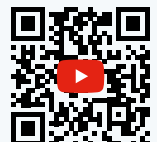

COOLCAP®

In Detail



Machine connection

COOLCAP®-arbors are available in the configurations

- HSK 63 Form A, HSK 100 Form A,
 - SK 40, SK 50,
 - BT 40 MAS BT JIS B 6339 AD, BT 50 MAS BT JIS B 6339 AD
- for shrinking and Weldon.

Cooling media

COOLCAP®-arbors are equipped with different caps for air/MQL or for emulsion.

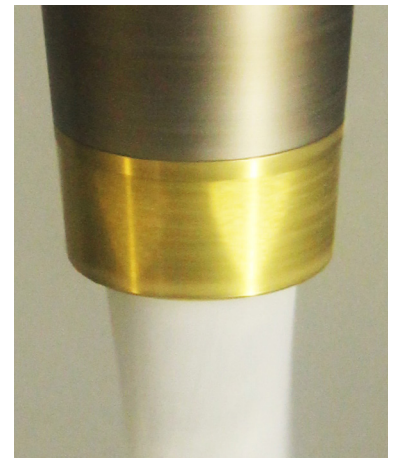
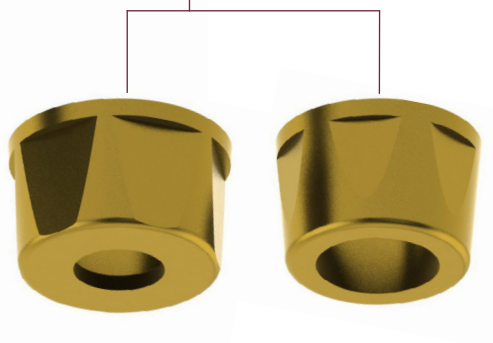

End mills

COOLCAP®-arbors are designed for solid carbide end mills and extensions

- Ø 6 to 16 mm by shrinking and
- Ø 10 to 16 mm for Weldon shank

COOLCAP® in action: uniform, ring-shaped cooling jet

Note about balancing:

For all arbors, the balance quality is:

- G 2,5 at 30.000 1/min or $U \leq 1\text{mm}$ at HSK 50 E
- G 2,5 at 25.000 1/min or $U \leq 1\text{mm}$ at HSK 63 A und HSK 100 A
- G 2,5 at 25.000 1/min or $U \leq 1\text{mm}$ at SK/BT 40 und SK/BT 50

This value is reliably achieved, even if the COOLCAP® caps are repeatedly loosened and replaced.









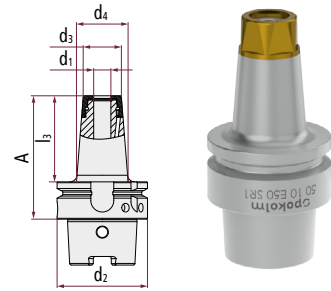



Furthermore, exchanging the caps for air cooling and caps for emulsion cooling also does not negatively influence the balance quality. That means risk of damage to the machine spindle due to changed balance qualities is generally excluded.

HSK 50 Form E

for shrinking

- Hollow taper shank arbors, maximum precision
- fine balanced to G 2,5 mm/s at 30.000 rpm or U<1gmm
- effective direct cooling for solid carbide end mills because of a ring-shaped cooling jet
- increased process reliability when using milling cutter bodies with indexable inserts in connection with extensions by removing the chips from the cutting area



	Catalogue no.	d ₁	l ₃	A	d ₃	d ₄	d ₂	DIN/Form	l ₂	l ₁	Accessories	Features	
for Ø 4	50 04 E50 SR1	4	50	76	15	23,4	HSK 50	Form E	-	-	A, B, C, G, L, M	<input checked="" type="checkbox"/> <input checked="" type="checkbox"/> <input checked="" type="checkbox"/> HSC <input checked="" type="checkbox"/> G 6.3 <input checked="" type="checkbox"/> 18.000	
	75 04 E50 SR1	4	75	101	15	27,3	HSK 50	Form E	-	-	A, B, C, G, L, M	<input checked="" type="checkbox"/> <input checked="" type="checkbox"/> <input checked="" type="checkbox"/> HSC <input checked="" type="checkbox"/> G 6.3 <input checked="" type="checkbox"/> 18.000	
	100 04 E50 SR1	4	100	126	15	31,3	HSK 50	Form E	-	-	A, B, C, G, L, M	<input checked="" type="checkbox"/> <input checked="" type="checkbox"/> <input checked="" type="checkbox"/> HSC <input checked="" type="checkbox"/> G 6.3 <input checked="" type="checkbox"/> 18.000	
for Ø 6	50 06 E50 SR1	6	50	76	16,5	24,4	HSK 50	Form E	-	-	A, B, C, H, L, M	<input checked="" type="checkbox"/> <input checked="" type="checkbox"/> <input checked="" type="checkbox"/> HSC <input checked="" type="checkbox"/> G 6.3 <input checked="" type="checkbox"/> 18.000	
	75 06 E50 SR1	6	75	101	16,5	28,33	HSK 50	Form E	-	-	A, B, C, H, L, M	<input checked="" type="checkbox"/> <input checked="" type="checkbox"/> <input checked="" type="checkbox"/> HSC <input checked="" type="checkbox"/> G 6.3 <input checked="" type="checkbox"/> 18.000	
	100 06 E50 SR1	6	100	126	16,5	32,27	HSK 50	Form E	-	-	A, B, C, H, L, M	<input checked="" type="checkbox"/> <input checked="" type="checkbox"/> <input checked="" type="checkbox"/> HSC <input checked="" type="checkbox"/> G 6.3 <input checked="" type="checkbox"/> 18.000	
for Ø 8	50 08 E50 SR1	8	50	76	20,5	28,4	HSK 50	Form E	-	-	A, B, D, I, L, M	<input checked="" type="checkbox"/> <input checked="" type="checkbox"/> <input checked="" type="checkbox"/> HSC <input checked="" type="checkbox"/> G 6.3 <input checked="" type="checkbox"/> 18.000	
	75 08 E50 SR1	8	75	101	20,5	32,33	HSK 50	Form E	-	-	A, B, D, I, L, M	<input checked="" type="checkbox"/> <input checked="" type="checkbox"/> <input checked="" type="checkbox"/> HSC <input checked="" type="checkbox"/> G 6.3 <input checked="" type="checkbox"/> 18.000	
	100 08 E50 SR1	8	100	126	20,5	36,27	HSK 50	Form E	-	-	A, B, D, I, L, M	<input checked="" type="checkbox"/> <input checked="" type="checkbox"/> <input checked="" type="checkbox"/> HSC <input checked="" type="checkbox"/> G 6.3 <input checked="" type="checkbox"/> 18.000	
for Ø 10	50 10 E50 SR1	10	50	76	22,5	30,4	HSK 50	Form E	-	-	A, B, E, J, L, M	<input checked="" type="checkbox"/> <input checked="" type="checkbox"/> <input checked="" type="checkbox"/> HSC <input checked="" type="checkbox"/> G 6.3 <input checked="" type="checkbox"/> 18.000	
	75 10 E50 SR1	10	75	101	22,5	34,3	HSK 50	Form E	-	-	A, B, E, J, L, M	<input checked="" type="checkbox"/> <input checked="" type="checkbox"/> <input checked="" type="checkbox"/> HSC <input checked="" type="checkbox"/> G 6.3 <input checked="" type="checkbox"/> 18.000	
	100 10 E50 SR1	10	100	126	22,5	34,3	HSK 50	Form E	-	-	A, B, E, J, L, M	<input checked="" type="checkbox"/> <input checked="" type="checkbox"/> <input checked="" type="checkbox"/> HSC <input checked="" type="checkbox"/> G 6.3 <input checked="" type="checkbox"/> 18.000	
for Ø 12	50 12 E50 SR1	12	50	76	26,5	34,4	HSK 50	Form E	-	-	A, B, F, K, L, M	<input checked="" type="checkbox"/> <input checked="" type="checkbox"/> <input checked="" type="checkbox"/> HSC <input checked="" type="checkbox"/> G 6.3 <input checked="" type="checkbox"/> 18.000	
	75 12 E50 SR1	12	75	101	26,5	38,33	HSK 50	Form E	-	-	A, B, F, K, L, M	<input checked="" type="checkbox"/> <input checked="" type="checkbox"/> <input checked="" type="checkbox"/> HSC <input checked="" type="checkbox"/> G 6.3 <input checked="" type="checkbox"/> 18.000	
	100 12 E50 SR1	12	100	126	26,5	40	HSK 50	Form E	-	-	A, B, F, K, L, M	<input checked="" type="checkbox"/> <input checked="" type="checkbox"/> <input checked="" type="checkbox"/> HSC <input checked="" type="checkbox"/> G 6.3 <input checked="" type="checkbox"/> 18.000	
Accessories > Seite 17	A  KMR-50A	B  SCHLUESSELHSK50	C  SR1 S06 SW17 Ø 6	D  SR1 S08 SW21 Ø 8	E  SR1 S10 SW22 Ø 10	F  SR1 S12 SW27 Ø 12	G  SR1 A04 SW17 Ø 4	H  SR1 A06 SW17 Ø 6	I  SR1 A08 SW21 Ø 8	J  SR1 A10 SW22 Ø 10	K  SR1 A12 SW27 Ø 12	L  SR1 ZSW 001	M  DMS 3/8 8-60 NM

HSK 63 Form A

for shrinking

- Hollow taper shank arbors, maximum precision
- fine balanced to G 2,5 mm/s at 25.000 rpm or U<1gmm
- effective direct cooling for solid carbide end mills because of a ring-shaped cooling jet
- increased process reliability when using milling cutter bodies with indexable inserts in connection with extensions by removing the chips from the cutting area

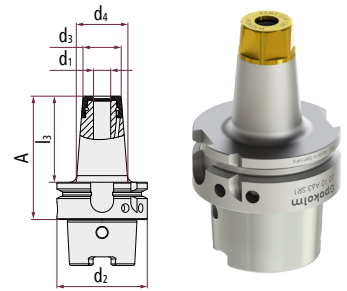

	Catalogue no.	d ₁	l ₃	A	d ₃	d ₄	d ₂	DIN/Form	l ₂	l ₁	Accessories	Features
for Ø 4	50 04 A63 SR1	4	50	76	15	22,9	HSK 63	Form A	-	-	A, B, C, I, P, Q	HSC G6.3 18.000
	75 04 A63 SR1	4	75	101	15	26,8	HSK 63	Form A	-	-	A, B, C, I, P, Q	HSC G6.3 18.000
	100 04 A63 SR1	4	100	126	15	30,8	HSK 63	Form A	-	-	A, B, C, I, P, Q	HSC G6.3 18.000
for Ø 6	50 06 A63 SR1	6	50	76	16,5	24,4	HSK 63	Form A	-	-	A, B, C, J, P, Q	HSC G6.3 18.000
	75 06 A63 SR1	6	75	101	16,5	28,4	HSK 63	Form A	-	-	A, B, C, J, P, Q	HSC G6.3 18.000
	100 06 A63 SR1	6	100	126	16,5	32,3	HSK 63	Form A	-	-	A, B, C, J, P, Q	HSC G6.3 18.000
for Ø 8	50 08 A63 SR1	8	50	76	20,5	27,4	HSK 63	Form A	-	-	A, B, D, K, P, Q	HSC G6.3 18.000
	75 08 A63 SR1	8	75	101	20,5	32,4	HSK 63	Form A	-	-	A, B, D, K, P, Q	HSC G6.3 18.000
	100 08 A63 SR1	8	100	126	20,5	36,3	HSK 63	Form A	-	-	A, B, D, K, P, Q	HSC G6.3 18.000
for Ø 10	50 10 A63 SR1	10	50	76	22,5	30,4	HSK 63	Form A	-	-	A, B, E, L, P, Q	HSC G6.3 18.000
	75 10 A63 SR1	10	75	101	22,5	34,3	HSK 63	Form A	-	-	A, B, E, L, P, Q	HSC G6.3 18.000
	100 10 A63 SR1	10	100	126	22,5	38,3	HSK 63	Form A	-	-	A, B, E, L, P, Q	HSC G6.3 18.000
for Ø 12	60 12 A63 SR1	12	60	86	26,5	36	HSK 63	Form A	-	-	A, B, F, M, P, Q	HSC G6.3 18.000
	75 12 A63 SR1	12	75	101	26,5	38,4	HSK 63	Form A	-	-	A, B, F, M, P, Q	HSC G6.3 18.000
	100 12 A63 SR1	12	100	126	26,5	42,3	HSK 63	Form A	-	-	A, B, F, M, P, Q	HSC G6.3 18.000
for Ø 16	60 16 A63 SR1	16	60	86	31,5	41	HSK 63	Form A	-	-	A, B, G, N, P, Q	HSC G6.3 18.000
	100 16 A63 SR1	16	100	126	31,5	47,3	HSK 63	Form A	-	-	A, B, G, N, P, Q	HSC G6.3 18.000
for Ø 20	60 20 A63 SR1	20	60	86	36	45	HSK 63	Form A	-	-	A, B, H, O, P, Q	HSC G6.3 18.000
	100 20 A63 SR1	20	100	126	36	51,3	HSK 63	Form A	-	-	A, B, H, O, P, Q	HSC G6.3 18.000
Accessories > Seite 17	A KMR-63A	B SCHLUESSELHSK63		C SR1 S06 SW17 Ø 6		D SR1 S08 SW21 Ø 8		E SR1 S10 SW22 Ø 10				
	F SR1 S12 SW27 Ø 12	G SR1 S16 SW32 Ø 16		H SR1 S20 SW36 Ø 20		I SR1 A04 SW17 Ø 4		J SR1 A06 SW17 Ø 6				
	K SR1 A08 SW21 Ø 8	L SR1 A10 SW22 Ø 10		M SR1 A12 SW27 Ø 12		N SR1 A16 SW32 Ø 16		O SR1 A20 SW36 Ø 20				
	P SR1 ZSW 001	Q DMS 3/8 8-60 NM										







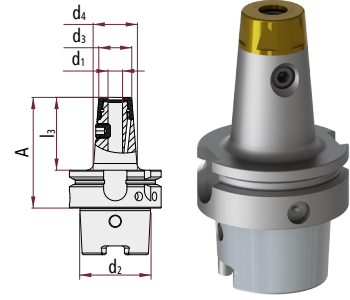









HSK 63 Form A

for Weldon

- Hollow taper shank arbors , maximum precision
- fine balanced to G 2,5 mm/s at 25.000 rpm or U<1gmm
- effective direct cooling for solid carbide end mills because of a ring-shaped cooling jet
- increased process reliability when using milling cutter bodies with indexable inserts in connection with extensions by removing the chips from the cutting area



	Catalogue no.	d ₁	l ₃	A	d ₃	d ₄	d ₂	DIN/Form	l ₂	l ₁	Accessories	Features
für Ø 10	50 10 A63 SR1 W	10	50	76	22,5	30,4	HSK 63	Form A	-	-	A, E, F, G, K, O, P	<input checked="" type="checkbox"/> <input checked="" type="checkbox"/> <input checked="" type="checkbox"/> <input checked="" type="checkbox"/> <input checked="" type="checkbox"/> HSC G6.3 18.000
für Ø 12	60 12 A63 SR1 W	12	60	86	26,5	36	HSK 63	Form A	-	-	B, E, F, H, L, O, P	<input checked="" type="checkbox"/> <input checked="" type="checkbox"/> <input checked="" type="checkbox"/> <input checked="" type="checkbox"/> <input checked="" type="checkbox"/> HSC G6.3 18.000
für Ø 16	60 16 A63 SR1 W	16	60	86	31,5	41	HSK 63	Form A	-	-	C, E, F, I, M, O, P	<input checked="" type="checkbox"/> <input checked="" type="checkbox"/> <input checked="" type="checkbox"/> <input checked="" type="checkbox"/> <input checked="" type="checkbox"/> HSC G6.3 18.000
für Ø 20	60 20 A63 SR1 W	20	60	86	36	45	HSK 63	Form A	-	-	D, E, F, L, N, O, P	<input checked="" type="checkbox"/> <input checked="" type="checkbox"/> <input checked="" type="checkbox"/> <input checked="" type="checkbox"/> <input checked="" type="checkbox"/> HSC G6.3 18.000

Accessories > Seite 17	A  M10X9 SR1 W	B  M12X10 SR1 W	C  M14X11 SR1 W	D  M16X10 SR1 W	E  KMR-63A
	F  SCHLUESSELHSK63	G  LSR1 S10 SW22 Ø 10	H  SR1 S12 SW27 Ø 12	I  SR1 S16 SW32 Ø 16	L  SR1 S20 SW36 Ø 20
	K  SR1 A10 SW22 Ø 10	L  SR1 A12 SW27 Ø 12	M  SR1 A16 SW32 Ø 16	N  SR1 A20 SW36 Ø 20	O  SR1 ZSW 001
	P  DMS 3/8 8-60 NM				

HSK 100 Form A

for shrinking

- Hollow taper shank arbors, maximum precision
- fine balanced to G 2,5 mm/s at 25.000 rpm
- effective direct cooling for solid carbide end mills because of a ring-shaped cooling jet
- increased process reliability when using milling cutter bodies with indexable inserts in connection with extensions by removing the chips from the cutting area

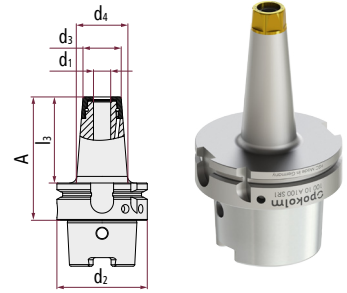

	Catalogue no.	d ₁	l ₃	A	d ₃	d ₄	d ₂	DIN/Form	l ₂	l ₁	Accessories	Features
für Ø6	100 06 A100 SR1	6	100	129	16,5	32,3	HSK 100	Form A	-	-	A, B, C, I, O, P	HSC G6.3 12.000
für Ø8	100 08 A100 SR1	8	100	129	20,5	36,3	HSK 100	Form A	-	-	A, B, D, J, O, P	HSC G6.3 12.000
für Ø10	100 10 A100 SR1	10	100	129	22,5	38,3	HSK 100	Form A	-	-	A, B, E, K, O, P	HSC G6.3 12.000
für Ø12	100 12 A100 SR1	12	100	129	26,5	42,3	HSK 100	Form A	-	-	A, B, F, L, O, P	HSC G6.3 12.000
für Ø16	100 16 A100 SR1	16	100	129	31,5	47,3	HSK 100	Form A	-	-	A, B, G, M, O, P	HSC G6.3 12.000
für Ø20	100 20 A100 SR1	20	100	129	35,5	51,3	HSK 100	Form A	-	-	A, B, H, N, O, P	HSC G6.3 12.000

Accessories > Seite 17	A KMR-100A	B SCHLUESSELHSK100	C SR1 S06 SW17 Ø6	D SR1 S08 SW21 Ø8	E SR1 S10 SW22 Ø10
	F SR1 S12 SW27 Ø12	G SR1 S16 SW32 Ø16	H SR1 S20 SW36 Ø20	I SR1 A06 SW17 Ø6	J SR1 A08 SW21 Ø8
	K SR1 A10 SW22 Ø10	L SR1 A12 SW27 Ø12	M SR1 A16 SW32 Ø16	N SR1 A20 SW36 Ø20	O SR1 ZSW 001
	P DMS 3/8 8-60 NM				

HSK 100 Form A

for Weldon

- Hollow taper shank arbors, maximum precision
- fine balanced to G 2,5 mm/s at 25.000 rpm
- effective direct cooling for solid carbide end mills because of a ring-shaped cooling jet
- increased process reliability when using milling cutter bodies with indexable inserts in connection with extensions by removing the chips from the cutting area

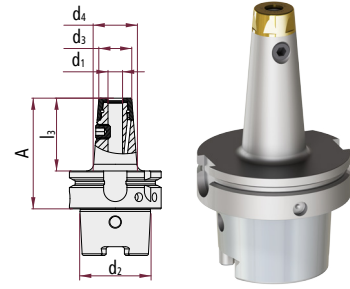

	Catalogue no.	d ₁	l ₃	A	d ₃	d ₄	d ₂	DIN/Form	l ₂	l ₁	Accessories	Features
für Ø 10	100 10 A100 SR1 W	10	100	129	22,5	38,3	HSK 100	Form A	-	-	A, E, F, G, K, O, P	☑ ☑ ☑ ☑ HSC G 6.3 12.000
für Ø 12	100 12 A100 SR1 W	12	100	129	26,5	42,3	HSK 100	Form A	-	-	B, E, F, H, L, O, P	☑ ☑ ☑ ☑ HSC G 6.3 12.000
für Ø 16	100 16 A100 SR1 W	16	100	129	31,5	47,3	HSK 100	Form A	-	-	C, E, F, I, M, O, P	☑ ☑ ☑ ☑ HSC G 6.3 12.000
für Ø 20	100 20 A100 SR1 W	20	100	129	35,5	51,3	HSK 100	Form A	-	-	D, E, F, L, N, O, P	☑ ☑ ☑ ☑ HSC G 6.3 12.000

Accessories > Seite 17	A	M10X9 SR1 W	B	M12X10 SR1 W	C	M14X11 SR1 W	D	M16X10 SR1 W	E	KMR-100A
	F	SCHLUESSELHSK100	G	LSR1 S10 SW22 Ø 10	H	SR1 S12 SW27 Ø 12	I	SR1 S16 SW32 Ø 16	L	SR1 S20 SW36 Ø 20
	K	SR1 A10 SW22 Ø 10	L	SR1 A12 SW27 Ø 12	M	SR1 A16 SW32 Ø 16	N	SR1 A20 SW36 Ø 20	O	SR1 ZSW 001
	P	DMS 3/8 8-60 NM								

SK 40

for shrinking

- Steep taper shank, maximum precision
- fine balanced to G 2,5 mm/s at 25.000 rpm or U<1gmm
- effective direct cooling for solid carbide end mills because of a ring-shaped cooling jet
- increased process reliability when using milling cutter bodies with indexable inserts in connection with extensions by removing the chips from the cutting area

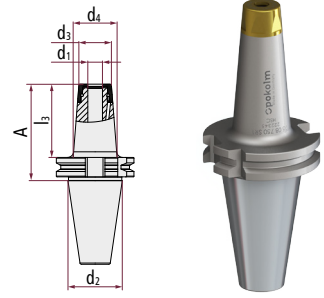

	Catalogue no.	d ₁	l ₃	A	d ₃	d ₄	d ₂	DIN/Form	l ₂	l ₁	Accessories	Features
for Ø 4	50 04 750 SR1	4	50	69,1	15	23,4	SK 40	-	-	-	A, B, H, O, P	
	75 04 750 SR1	4	75	94,1	15	27,3	SK 40	-	-	-	A, B, H, O, P	
	100 04 750 SR1	4	100	119,1	15	31,3	SK 40	-	-	-	A, B, H, O, P	
for Ø 6	50 06 750 SR1	6	50	69,1	16,5	24,4	SK 40	-	-	-	A, B, I, O, P	
	75 06 750 SR1	6	75	94,1	16,5	28,3	SK 40	-	-	-	A, B, I, O, P	
	100 06 750 SR1	6	100	119,1	16,5	32,3	SK 40	-	-	-	A, B, I, O, P	
for Ø 8	50 08 750 SR1	8	50	69,1	20,5	28,4	SK 40	-	-	-	A, C, J, O, P	
	75 08 750 SR1	8	75	94,1	20,5	32,3	SK 40	-	-	-	A, C, J, O, P	
	100 08 750 SR1	8	100	119,1	20,5	36,3	SK 40	-	-	-	A, C, J, O, P	
for Ø 10	50 10 750 SR1	10	50	69,1	22,5	30,4	SK 40	-	-	-	A, D, K, O, P	
	75 10 750 SR1	10	75	94,1	22,5	34,3	SK 40	-	-	-	A, D, K, O, P	
	100 10 750 SR1	10	100	119,1	22,5	38,3	SK 40	-	-	-	A, D, K, O, P	
for Ø 12	60 12 750 SR1	12	60	79,1	26,5	36	SK 40	-	-	-	A, E, L, O, P	
	75 12 750 SR1	12	75	94,1	26,5	38,3	SK 40	-	-	-	A, E, L, O, P	
	100 12 750 SR1	12	100	119,1	26,5	42,3	SK 40	-	-	-	A, E, L, O, P	
for Ø 16	60 16 750 SR1	16	60	79,1	31,5	41	SK 40	-	-	-	A, F, M, O, P	
	100 16 750 SR1	16	100	119,1	31,5	47,3	SK 40	-	-	-	A, F, M, O, P	
for Ø 20	60 20 750 SR1	20	60	79,1	36	45	SK 40	-	-	-	A, G, N, O, P	
	100 20 750 SR1	20	100	119,1	36	51,3	SK 40	-	-	-	A, G, N, O, P	

Accessories > Seite 17	A KBSK40-69872A	B SR1 S06 SW17 Ø 6	C SR1 S08 SW21 Ø 8	D SR1 S10 SW22 Ø 10	E SR1 S12 SW27 Ø 12
	F SR1 S16 SW32 Ø 16	G SR1 S20 SW36 Ø 20	H SR1 A04 SW17 Ø 4	I SR1 A06 SW17 Ø 6	J SR1 A08 SW21 Ø 8
	K SR1 A10 SW22 Ø 10	L SR1 A12 SW27 Ø 12	M SR1 A16 SW32 Ø 16	N SR1 A20 SW36 Ø 20	O SR1 ZSW 001
	P DMS 3/8 8-60 NM				

SK 40

for Weldon

- Steep taper shanks, maximum precision
- fine balanced to G 2,5 mm/s at 25.000 rpm or U<1gmm
- effective direct cooling for solid carbide end mills because of a ring-shaped cooling jet
- increased process reliability when using milling cutter bodies with indexable inserts in connection with extensions by removing the chips from the cutting area

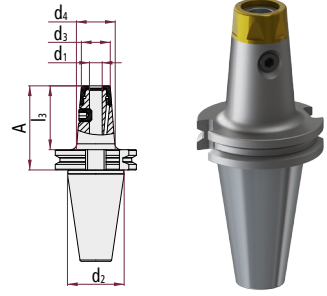

	Catalogue no.	d ₁	l ₃	A	d ₃	d ₄	d ₂	DIN/Form	l ₂	l ₁	Accessories	Features
für Ø 10	50 10 750 SR1 W	10	50	69,1	22,5	30,4	SK 40	-	-	-	A, E, F, J, N, O	☑ ■ ■ ■ [HSC] G 6.3 18.000
für Ø 12	60 12 750 SR1 W	12	60	79,1	26,5	36	SK 40	-	-	-	B, E, G, K, N, O	☑ ■ ■ ■ [HSC] G 6.3 18.000
für Ø 16	60 16 750 SR1 W	16	60	79,1	31,5	41	SK 40	-	-	-	C, E, H, L, N, O	☑ ■ ■ ■ [HSC] G 6.3 18.000
für Ø 20	60 20 750 SR1 W	20	60	79,1	36	45	SK 40	-	-	-	D, E, I, M, N, O	☑ ■ ■ ■ [HSC] G 6.3 18.000
Accessories > Seite 17	A M10X9 SR1 W	B M12X10 SR1 W		C M14X11 SR1 W		D M16X10 SR1 W		E KBSK40-69872A				
	F LSR1 S10 SW22 Ø 10	G SR1 S12 SW27 Ø 12		H SR1 S16 SW32 Ø 16		I SR1 S20 SW36 Ø 20		J SR1 A10 SW22 Ø 10				
	K SR1 A12 SW27 Ø 12	L SR1 A16 SW32 Ø 16		M SR1 A20 SW36 Ø 20		N SR1 ZSW 001		O DMS 3/8 8-60 NM				

SK 50

for shrinking

- Steep taper shanks, maximum precision
- fine balanced to G 2,5 mm/s at 25.000 rpm
- effective direct cooling for solid carbide end mills because of a ring-shaped cooling jet
- increased process reliability when using milling cutter bodies with indexable inserts in connection with extensions by removing the chips from the cutting area

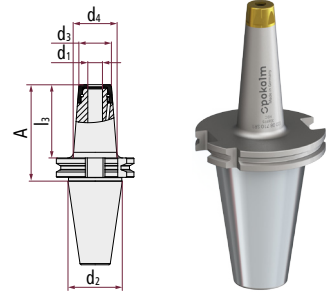

	Catalogue no.	d ₁	l ₃	A	d ₃	d ₄	d ₂	DIN/Form	l ₂	l ₁	Accessories	Features
für Ø 6	100 06 710 SR1	6	100	119,1	16,5	32,3	SK 50	-	-	-	A, B, H, N, O	
für Ø 8	100 08 710 SR1	8	100	119,1	20,5	36,3	SK 50	-	-	-	A, C, I, N, O	
für Ø 10	100 10 710 SR1	10	100	119,1	22,5	38,3	SK 50	-	-	-	A, D, J, N, O	
für Ø 12	100 12 710 SR1	12	100	119,1	26,5	42,3	SK 50	-	-	-	A, E, K, N, O	
für Ø 16	100 16 710 SR1	16	100	119,1	31,5	47,3	SK 50	-	-	-	A, F, L, N, O	
für Ø 20	100 20 710 SR1	20	100	119,1	35,5	51,5	SK 50	-	-	-	A, G, M, N, O	
Accessories > Seite 17	A KBSK50-69872A	B SR1 S06 SW17 Ø 6		C SR1 S08 SW21 Ø 8		D SR1 S10 SW22 Ø 10		E SR1 S12 SW27 Ø 12				
	F SR1 S16 SW32 Ø 16	G SR1 S20 SW36 Ø 20		H SR1 A06 SW17 Ø 6		I SR1 A08 SW21 Ø 8		J SR1 A10 SW22 Ø 10				
	K SR1 A12 SW27 Ø 12	L SR1 A16 SW32 Ø 16		M SR1 A20 SW36 Ø 20		N SR1 ZSW 001		O DMS 3/8 8-60 NM				

SK 50

for Weldon

- Steep taper shanks, maximum precision
- fine balanced to G 2,5 mm/s at 25.000 rpm
- effective direct cooling for solid carbide end mills because of a ring-shaped cooling jet
- increased process reliability when using milling cutter bodies with indexable inserts in connection with extensions by removing the chips from the cutting area

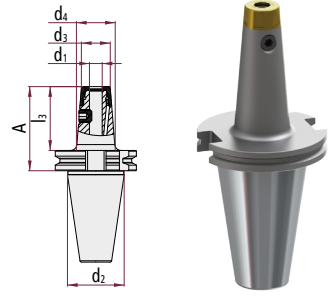









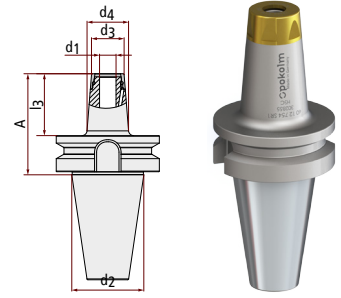



	Catalogue no.	d ₁	l ₃	A	d ₃	d ₄	d ₂	DIN/Form	l ₂	l ₁	Accessories	Features
für Ø 10	100 10 710 SR1 W	10	100	119,1	22,5	38,3	SK 50	-	-	-	A, E, G, K, O, P	<input checked="" type="checkbox"/> <input checked="" type="checkbox"/> <input checked="" type="checkbox"/> <input checked="" type="checkbox"/> HSC G16 8.000
für Ø 12	100 12 710 SR1 W	12	100	119,1	26,5	42,3	SK 50	-	-	-	B, E, H, L, O, P	<input checked="" type="checkbox"/> <input checked="" type="checkbox"/> <input checked="" type="checkbox"/> <input checked="" type="checkbox"/> HSC G16 8.000
für Ø 16	100 16 710 SR1 W	16	100	119,1	31,5	47,3	SK 50	-	-	-	C, E, I, M, O, P	<input checked="" type="checkbox"/> <input checked="" type="checkbox"/> <input checked="" type="checkbox"/> <input checked="" type="checkbox"/> HSC G16 8.000
für Ø 20	100 20 710 SR1 W	20	100	119,1	35,5	51,5	SK 50	-	-	-	D, E, F, J, N, O, P	<input checked="" type="checkbox"/> <input checked="" type="checkbox"/> <input checked="" type="checkbox"/> <input checked="" type="checkbox"/> HSC G2,5 25.000
Accessories > Seite 17	A M10X9 SR1 W	B M12X10 SR1 W	C M14X11 SR1 W	D M16X10 SR1 W	E KBSK50-69872A							
	F KBSK50-69872B	G SR1 S10 SW22 Ø 10	H SR1 S12 SW27 Ø 12	I SR1 S16 SW32 Ø 16	J SR1 S20 SW36 Ø 20							
	K SR1 A10 SW22 Ø 10	L SR1 A12 SW27 Ø 12	M SR1 A16 SW32 Ø 16	N SR1 A20 SW36 Ø 20	O SR1 ZSW 001							
	P DMS 3/8 8-60 NM											

BT 40 MAS BT

for shrinking

- Steep taper shanks according to JIS B 6339 AD, maximum precision
- fine balanced to G 2,5 mm/s at 25.000 rpm or U<1gmm
- effective direct cooling for solid carbide end mills because of a ring-shaped cooling jet
- increased process reliability when using milling cutter bodies with indexable inserts in connection with extensions by removing the chips from the cutting area



	Catalogue no.	d ₁	l ₃	A	d ₃	d ₄	d ₂	DIN/Form	l ₂	l ₁	Accessories	Features
für Ø6	50 06 754 SR1	6	50	77	16,5	24,4	BT 40	JIS B 6339 AD	-	-	A, F, K, L	<input checked="" type="checkbox"/> <input checked="" type="checkbox"/> <input checked="" type="checkbox"/> <input checked="" type="checkbox"/> G 6.3 18.000
für Ø8	50 08 754 SR1	8	50	77	20,5	28,4	BT 40	JIS B 6339 AD	-	-	B, G, K, L	<input checked="" type="checkbox"/> <input checked="" type="checkbox"/> <input checked="" type="checkbox"/> <input checked="" type="checkbox"/> G 6.3 18.000
für Ø10	50 10 754 SR1	10	50	77	22,5	30,4	BT 40	JIS B 6339 AD	-	-	C, H, K, L	<input checked="" type="checkbox"/> <input checked="" type="checkbox"/> <input checked="" type="checkbox"/> <input checked="" type="checkbox"/> G 6.3 18.000
für Ø12	60 12 754 SR1	12	60	87	26,5	36	BT 40	JIS B 6339 AD	-	-	D, I, K, L	<input checked="" type="checkbox"/> <input checked="" type="checkbox"/> <input checked="" type="checkbox"/> <input checked="" type="checkbox"/> G 6.3 18.000
für Ø16	60 16 754 SR1	16	60	87	31,5	41	BT 40	JIS B 6339 AD	-	-	E, J, K, L	<input checked="" type="checkbox"/> <input checked="" type="checkbox"/> <input checked="" type="checkbox"/> <input checked="" type="checkbox"/> G 6.3 18.000
Accessories > Seite 17	A  SR1 S06 SW17 Ø 6	B  SR1 S08 SW21 Ø 8	C  SR1 S10 SW22 Ø 10	D  SR1 S12 SW27 Ø 12	E  SR1 S16 SW32 Ø 16							
	F  SR1 A06 SW17 Ø 6	G  SR1 A08 SW21 Ø 8	H  SR1 A10 SW22 Ø 10	I  SR1 A12 SW27 Ø 12	J  SR1 A16 SW32 Ø 16							
	K  SR1 ZSW 001	L  DMS 3/8 8-60 NM										

BT 40 MAS BT

for Weldon

- Steep taper shanks according to JIS B 6339 AD, maximum precision
- fine balanced to G 2,5 mm/s at 25.000 rpm or U<1gmm
- effective direct cooling for solid carbide end mills because of a ring-shaped cooling jet
- increased process reliability when using milling cutter bodies with indexable inserts in connection with extensions by removing the chips from the cutting area

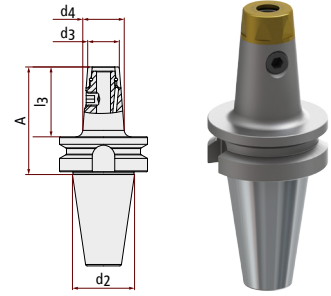









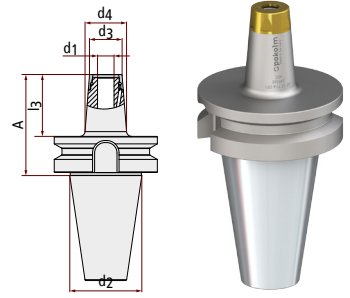



	Catalogue no.	d ₁	l ₃	A	d ₃	d ₄	d ₂	DIN/Form	l ₂	l ₁	Accessories	Features
für Ø 10	50 10 754 SR1 W	10	50	77	22,5	30,4	BT 40	JIS B 6339 AD	-	-	A, D, G, J, K	✓ ■ ■ ■ ■ [HSC] [G 6.3 10.000]
für Ø 12	60 12 754 SR1 W	12	60	87	26,5	36	BT 40	JIS B 6339 AD	-	-	B, E, H, J, K	✓ ■ ■ ■ ■ [HSC] [G 6.3 10.000]
für Ø 16	60 16 754 SR1 W	16	60	87	31,5	41	BT 40	JIS B 6339 AD	-	-	C, F, I, J, K	✓ ■ ■ ■ ■ [HSC] [G 6.3 10.000]
Accessories > Seite 17	A M10X9 SR1 W	B M12X10 SR1 W		C M14X11 SR1 W		D SR1 S10 SW22 Ø 10		E SR1 S12 SW27 Ø 12				
	F SR1 S16 SW32 Ø 16	G SR1 A10 SW22 Ø 10		H SR1 A12 SW27 Ø 12		I SR1 A16 SW32 Ø 16		J SR1 ZSW 001				
	K DMS 3/8 8-60 NM											

BT 50 MAS BT

for shrinking

- Steep taper shanks according to JIS B 6339 AD, maximum precision
- fine balanced to G 2,5 mm/s at 25.000 rpm
- effective direct cooling for solid carbide end mills because of a ring-shaped cooling jet
- increased process reliability when using milling cutter bodies with indexable inserts in connection with extensions by removing the chips from the cutting area



	Catalogue no.	d ₁	l ₃	A	d ₃	d ₄	d ₂	DIN/Form	l ₂	l ₁	Accessories	Features
für Ø6	50 06 714 SR1	6	50	88	16,5	24,4	BT 50	JIS B 6339 AD	-	-	A, F, K, L	<input checked="" type="checkbox"/> <input checked="" type="checkbox"/> <input checked="" type="checkbox"/> HSC <input checked="" type="checkbox"/> G16 8.000
für Ø8	50 08 714 SR1	8	50	88	20,5	28,4	BT 50	JIS B 6339 AD	-	-	B, G, K, L	<input checked="" type="checkbox"/> <input checked="" type="checkbox"/> <input checked="" type="checkbox"/> HSC <input checked="" type="checkbox"/> G16 8.000
für Ø10	50 10 714 SR1	10	50	88	22,5	30,4	BT 50	JIS B 6339 AD	-	-	C, H, K, L	<input checked="" type="checkbox"/> <input checked="" type="checkbox"/> <input checked="" type="checkbox"/> HSC <input checked="" type="checkbox"/> G16 8.000
für Ø12	60 12 714 SR1	12	60	98	26,5	36	BT 50	JIS B 6339 AD	-	-	D, I, K, L	<input checked="" type="checkbox"/> <input checked="" type="checkbox"/> <input checked="" type="checkbox"/> HSC <input checked="" type="checkbox"/> G16 8.000
für Ø16	60 16 714 SR1	16	60	98	32	41	BT 50	JIS B 6339 AD	-	-	E, J, K, L	<input checked="" type="checkbox"/> <input checked="" type="checkbox"/> <input checked="" type="checkbox"/> HSC <input checked="" type="checkbox"/> G16 8.000
Accessories > Seite 17	A  SR1 S06 SW17 Ø6	B  SR1 S08 SW21 Ø8	C  SR1 S10 SW22 Ø10	D  SR1 S12 SW27 Ø12	E  SR1 S16 SW32 Ø16							
	F  SR1 A06 SW17 Ø6	G  SR1 A08 SW21 Ø8	H  SR1 A10 SW22 Ø10	I  SR1 A12 SW27 Ø12	J  SR1 A16 SW32 Ø16							
	K  SR1 ZSW 001	L  DMS 3/8 8-60 NM										

BT 50 MAS BT

for Weldon

- Steep taper shanks according to JIS B 6339 AD, maximum precision
- fine balanced to G 2,5 mm/s at 25.000 rpm
- effective direct cooling for solid carbide end mills because of a ring-shaped cooling jet
- increased process reliability when using milling cutter bodies with indexable inserts in connection with extensions by removing the chips from the cutting area

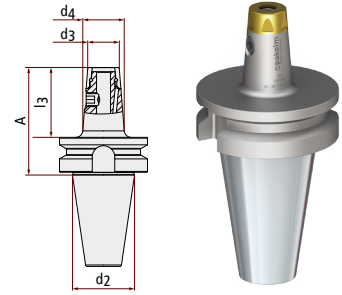

	Catalogue no.	d ₁	l ₃	A	d ₃	d ₄	d ₂	DIN/Form	l ₂	l ₁	Accessories	Features
für Ø 10	50 10 714 SR1 W	10	50	88	22,5	30,4	BT 50	JIS B 6339 AD	-	-	A, D, G, J, K	<input checked="" type="checkbox"/> <input checked="" type="checkbox"/> <input checked="" type="checkbox"/> <input checked="" type="checkbox"/> HSC G 16 8.000
für Ø 12	60 12 714 SR1 W	12	60	98	26,5	36	BT 50	JIS B 6339 AD	-	-	B, E, H, J, K	<input checked="" type="checkbox"/> <input checked="" type="checkbox"/> <input checked="" type="checkbox"/> <input checked="" type="checkbox"/> HSC G 16 8.000
für Ø 16	60 16 714 SR1 W	16	60	98	31,5	41	BT 50	JIS B 6339 AD	-	-	C, F, I, J, K	<input checked="" type="checkbox"/> <input checked="" type="checkbox"/> <input checked="" type="checkbox"/> <input checked="" type="checkbox"/> HSC G 16 8.000
Accessories > Seite 17	A M10X9 SR1 W	B M12X10 SR1 W	C M14X11 SR1 W	D SR1 S10 SW22 Ø 10	E SR1 S12 SW27 Ø 12							
	F SR1 S16 SW32 Ø 16	G SR1 A10 SW22 Ø 10	H SR1 A12 SW27 Ø 12	I SR1 A16 SW32 Ø 16	J SR1 ZSW 001							
	K DMS 3/8 8-60 NM											

The COOLCAP® application tool



The COOLCAP® application tool is for universal use.

One single tool is sufficient for process-reliable attaching and removing all COOLCAP® caps.

That means you profit from minimum stock and the bothersome search for the right box wrench or other suitable tools is eliminated.

The various wrench widths are clearly marked - each appropriate tightening torque is indicated. That makes operating mistakes virtually impossible with the COOLCAP® system and guarantees long service lives for the caps.

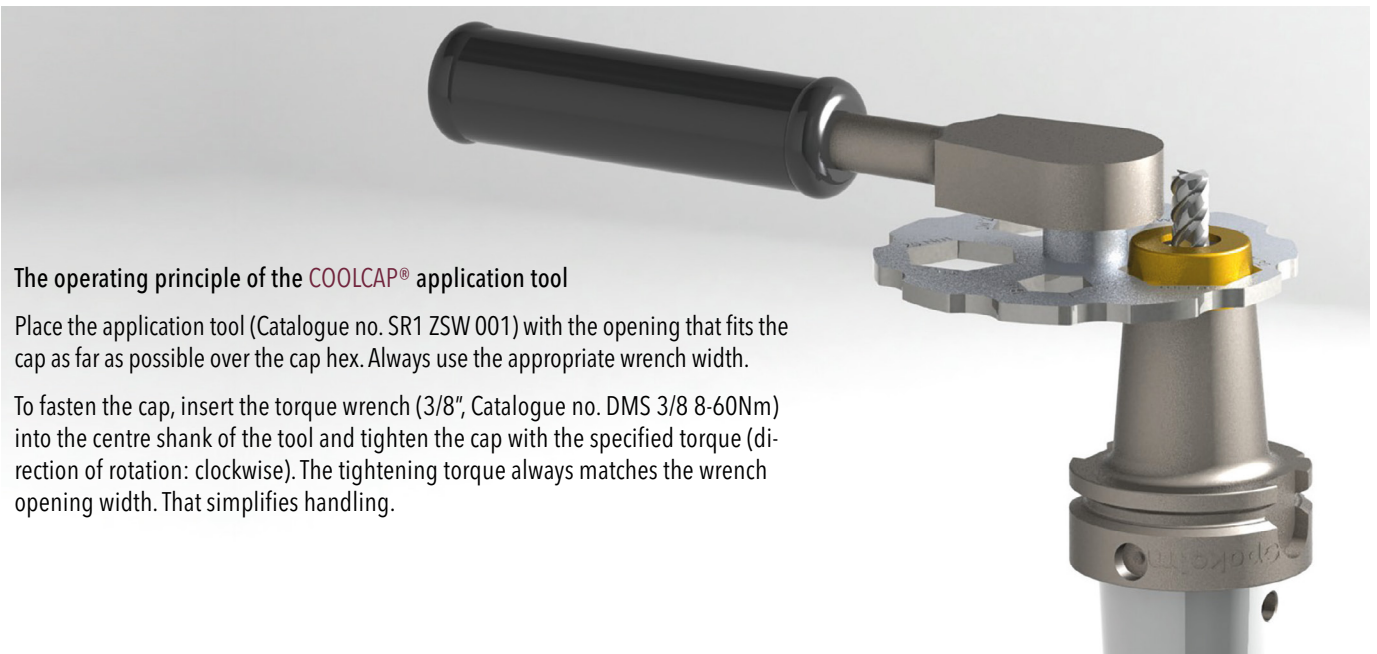

The operating principle of the COOLCAP® application tool

Place the application tool (Catalogue no. SR1 ZSW 001) with the opening that fits the cap as far as possible over the cap hex. Always use the appropriate wrench width.

To fasten the cap, insert the torque wrench (3/8", Catalogue no. DMS 3/8 8-60Nm) into the centre shank of the tool and tighten the cap with the specified torque (direction of rotation: clockwise). The tightening torque always matches the wrench opening width. That simplifies handling.



Tool diameter (mm)	Wrench size (mm)	Tightening torque (Nm)
6	17	17
8	21	21
10	22	22
12	27	27
16	32	32
20	36	42

For long service life and process-reliable tightening and loosening of the caps, compliance with the specified tightening torques is mandatory.

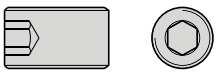
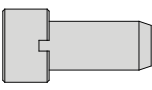
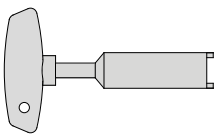
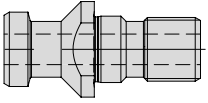

Important operating instructions - please comply!

- When shrink gripping and shrink releasing tools, always remove the COOLCAP® system caps
- Never seal COOLCAP® with additional sealants such as PTFE thread seal tape or anything similar
- Never use an open-end wrench, pipe wrench or adjustable screw-wrench to tighten and loosen the caps
- The use of unsuitable tools voids the guaranty

Accessories

	Catalogue no.	Description				
setscrew						
	M10X9 SR1 W	Screw according to DIN 1835-2	M10	Weldon	Ø 10	
	M12X10 SR1 W	Screw according to DIN 1835-2	M12	Weldon	Ø 12	
	M14X11 SR1 W	Screw according to DIN 1835-2	M14	Weldon	Ø 16	
	M16X10 SR1 W	Screw according to DIN 1835-2	M16	Weldon	Ø 20	
Coolant supply tube for HSK tooling						
	KMR-50A	Coolant supply tube for HSK-tooling	for HSK 50	Form A + E		
	KMR-63A	Coolant supply tube for HSK-tooling	for HSK 63	Form A + E		
	KMR-100A	Coolant supply tube for HSK-tooling	for HSK 100	Form A		
Spanners for coolant supply tube						
	SCHLUESSELHSK50	Montageschlüssel für Kühlmittelröhrchen	HSK 50			
	SCHLUESSELHSK63	Montageschlüssel für Kühlmittelröhrchen	HSK 63			
	SCHLUESSELHSK100	Montageschlüssel für Kühlmittelröhrchen	HSK 100			
Retention knobs without seal ring groove						
	KBSK40-69872A	Retention knob with through hole	SK 40	DIN 69 872 A	with sealing ring groove	
	KBSK50-69872A	Retention knob with through hole	SK 50	DIN 69 872 A	with sealing ring groove	
CoolCap® for water / emulsion cooling						
	SR1 S06 SW17	COOLCAP®-Screw-On Cap for shrinking Ø 6 for water / emulsion cooling				
	SR1 S08 SW21	COOLCAP®-Screw-On Cap for shrinking Ø 8 for water / emulsion cooling				
	SR1 S10 SW22	COOLCAP®-Screw-On Cap for shrinking Ø 10 for water / emulsion cooling				
	SR1 S12 SW27	COOLCAP®-Screw-On Cap for shrinking Ø 12 for water / emulsion cooling				
	SR1 S16 SW32	COOLCAP®-Screw-On Cap for shrinking Ø 16 for water / emulsion cooling				
	SR1 S20 SW36	COOLCAP®-Screw-On Cap for shrinking Ø 20 for water / emulsion cooling				

Accessories

	Catalogue no.	Description				
CoolCap® for air cooling and MQL						
	SR1 A04 SW17	COOLCAP®-Screw-On Cap for shrinking Ø 4 for air cooling and MQL				
	SR1 A06 SW17	COOLCAP®-Screw-On Cap for shrinking Ø 6 for air cooling and MQL				
	SR1 A08 SW21	COOLCAP®-Screw-On Cap for shrinking Ø 8 for air cooling and MQL				
	SR1 A10 SW22	COOLCAP®-Screw-On Cap for shrinking Ø 10 for air cooling and MQL				
	SR1 A12 SW27	COOLCAP®-Screw-On Cap for shrinking Ø 12 for air cooling and MQL				
	SR1 A16 SW32	COOLCAP®-Screw-On Cap for shrinking Ø 16 for air cooling and MQL				
	SR1 A20 SW36	COOLCAP®-Screw-On Cap for shrinking Ø 20 for air cooling and MQL				
CoolCap® Applying tool						
	SR1 ZSW 001	COOLCAP®-applying tool SR1 universal key				
CoolCap® Torque wrench						
	DMS 3/8 8-60 NM	torque wrench 3/8" für SR1 ZSW 001				

Pokolm Frästechnik GmbH & Co. KG

Adam-Opel-Straße 5, 33428 Harsewinkel - Germany
+49 5247 9361-0, info@pokolm.de



www.pokolm.de