

DEVVRAN

DIŞLI-GEAR

Kalite · Güven · Tecrübe
quality · safety · experience

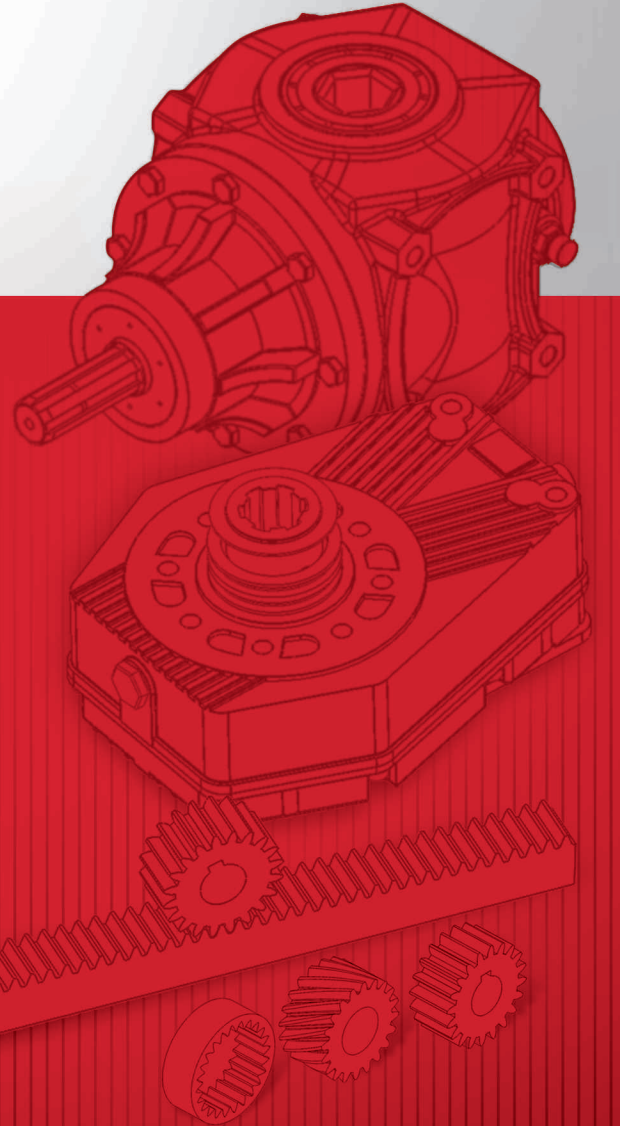

ROTOTİLLER ŞANZIMANI
Rotary Tiller Gear Box

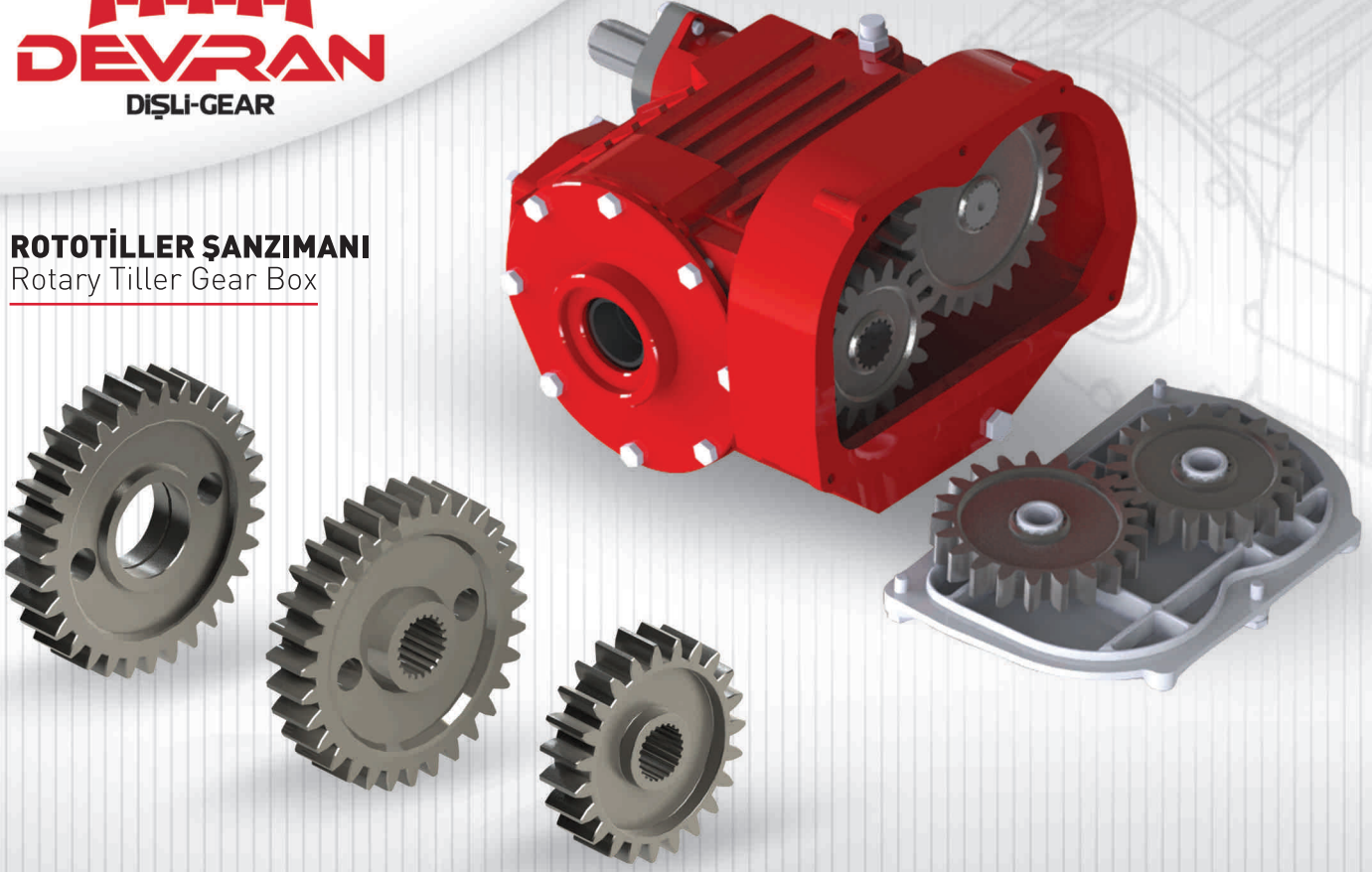

Özellikler / Specifications

Ürün Adı
Product Name

Rototiller Şanzımanı / Rotary Tiller Gear Box

Vites / Gearshift	1.Vites First Gear	2.Vites Second Gear	3.Vites Third Gear	4.Vites Fourth Gear
Dişli Düzeni / Gear Arrangement	17-23	19-21	21-19	23-17
Çevrim Oranı / Gear Ratio	2,80:1	2,28:1	1,87:1	1,53:1
Giriş Devri / Input Speed	540 r.p.m.			
Çıkış Devri / Output Speed	193 r.p.m	236 r.p.m	288 r.p.m	353 r.p.m
Yağ Cinsi / Oil Grade	SAE90&SAE140			
Yağ Hacmi / Oil Volume	3,50 lt.			

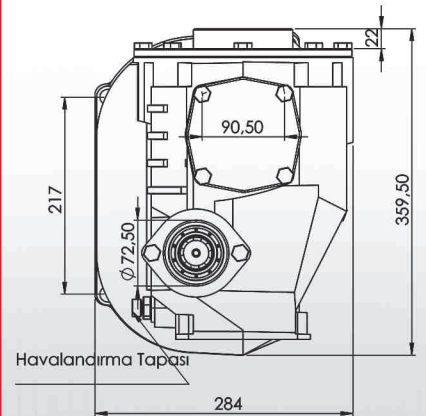
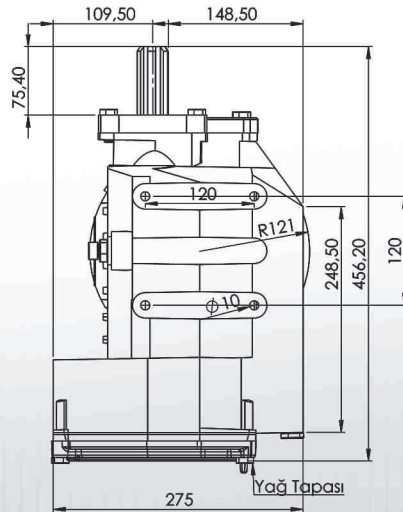
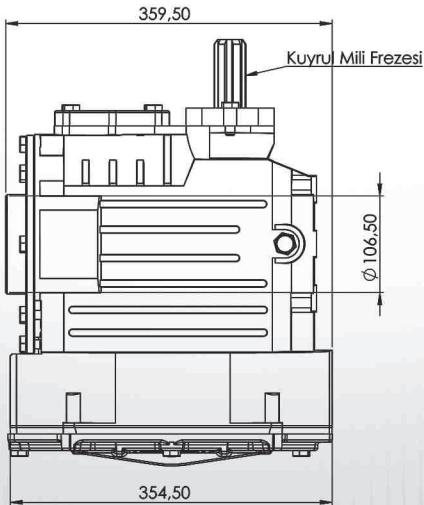

SIRA ARASI ÇAPA ŐANZIMANI

Inter Row Rotary Cultivator Gear Box

Özellikler / Specifications

Ürün Adı Product Name	Sıra Arası Çapa Őanzimini Inter Row Rotary Cultivator Gear Box
Giriő Devri / Input Speed	540 r.p.m
Çıkıő Devri / Output Speed	290 r.p.m.
Çevrim Oranı / Gear Ratio	1,86:1
Yağ Cinsi / Oil Grade	SAE90&SAE140
Yağ Hacmi / Oil Volume	1,30

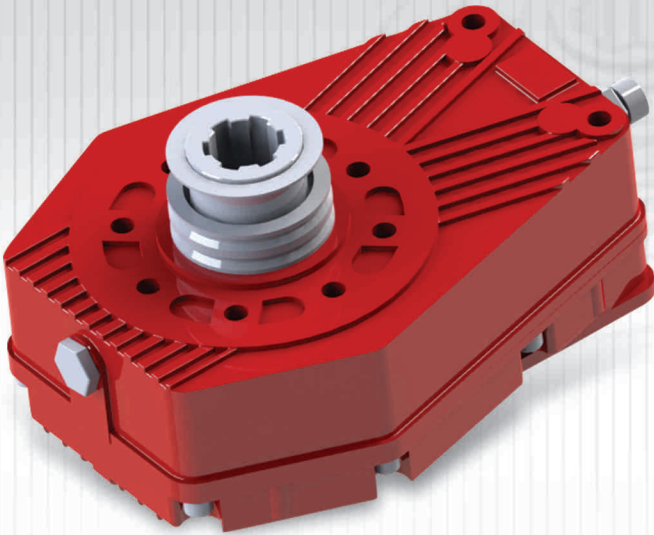
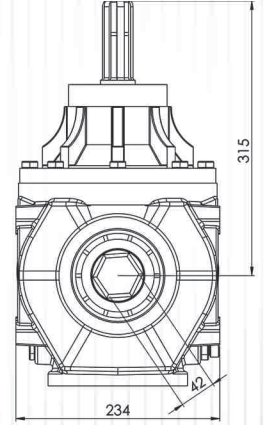
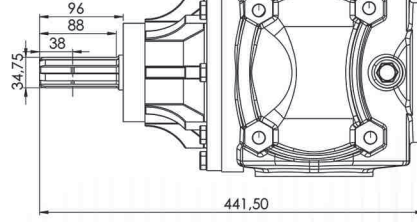
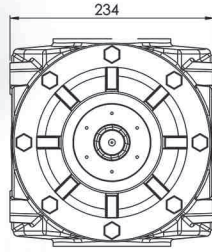
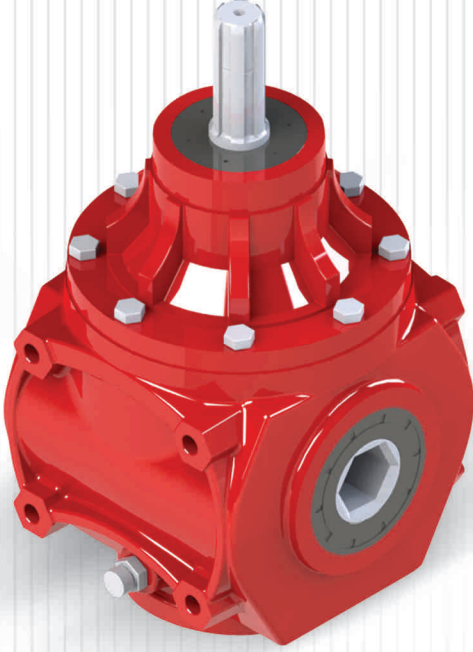

ML-52 DEVİR YÜKSELTİCİ

Speed Booster

Özellikler / Specifications

Ürün Adı Product Name	ML-52 Devir Yükseltici / Speed Booster
Giriő Devri / Input Speed	540 r.p.m
Çıkıő Devri / Output Speed	1620 r.p.m
Çevrim Oranı / Gear Ratio	1:3
Yağ Cinsi / Oil Grade	SAE90&SAE140
Yağ Hacmi / Oil Volume	1 lt.

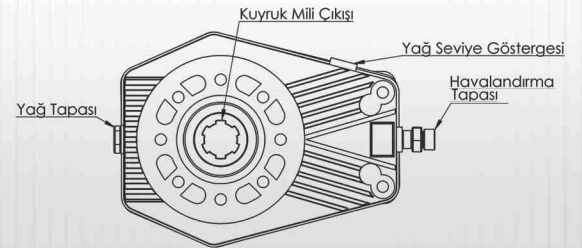
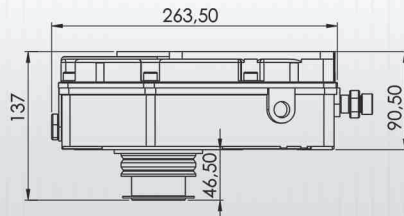
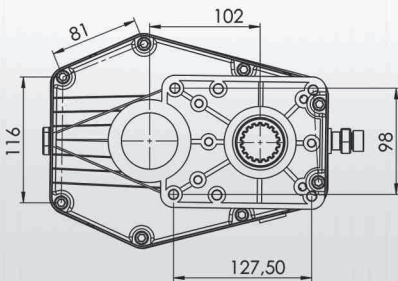

TAMBURLU ÇAYIR BİÇME DİŞLİ TAKIMI
Rotary Drum Mower Gear Set



Özellikler / Specifications

Ürün Adı Product Name	Düz Konik Dişli / Straight Bevel Gear		
Min. Modül / Min. Module	1 MN.	Min. Çap / Min.Dia.	30 mm.
Max. Modül / Max. Module	10 MN.	Max. Çap / Max. Dia.	300 mm.

BALYA MAKİNASI DİŞLİ TAKIMI
Baler Machine Gear Set



ISTAVROZ KİTİ

Spiders Sets

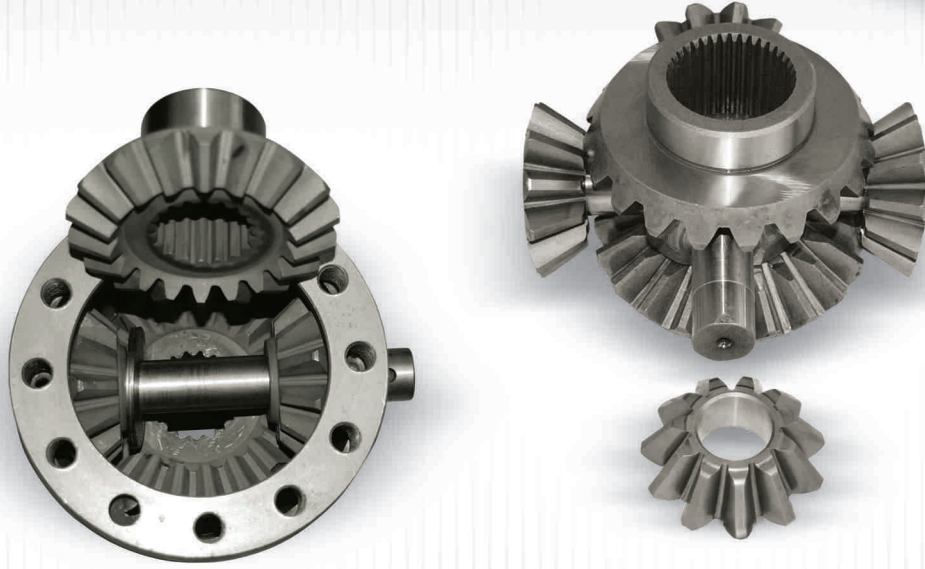

Özellikler / Specifications

Ürün Adı Product Name	Istavroz ve Aks Dişlileri / Spider and Axle Gears		
Min. Modül / Min. Module	1 MN.	Min. Çap / Min. Dia.	30 mm.
Max. Modül / Max. Module	10 MN.	Max. Çap / Max. Dia.	300 mm.

AYNA MAHRUTİ

Spiral Bevel Gear



Patoz Dişli Takımı / Seed Thresher Gear Set

Özellikler / Specifications

Ürün Adı Product Name	Ayna Mahrutü / Spiral Bevel Gear		
Min. Modül / Min. Module	1 MN.	Min. Çap / Min. Dia.	30 mm.
Max. Modül / Max. Module	7 MN.	Max. Çap / Max. Dia.	300 mm.

KRAMAYER DİŞLİ
Rack Gear



Özellikler / Specifications

Ürün Adı Product Name	Kramayer Dişli / Rack Gear		
Min. Modül / Min. Module	1 MN.	Min. Kalınlık / Min. Thickness	20x20 mm.
Max. Modül / Max. Module	6 MN.	Max. Kalınlık / Max. Thickness	50x50 mm.

CER DİŞLİ
Planetary Gear Set



SİLİNDİRİK DÜZ DİŞLİ
Spur Gear



Özellikler / Specifications

Ürün Adı Product Name	Silindirik Düz Dişli / Spur Gear		
Min. Modül / Min. Module	1 MN.	Min. Çap / Min. Dia.	30 mm.
Max. Modül / Max. Module	10 MN.	Max. Çap / Max. Dia.	1000 mm.

HELİS DİŞLİ

Helical Gear



Özellikler / Specifications

Ürün Adı Product Name	Helis Dişli / Helical Gear		
Min. Modül / Min. Module	1 MN.	Min. Çap / Min.Dia.	30 mm.
Max. Modül / Max. Module	6 MN.	Max. Çap / Max.Dia.	500 mm.

SONSUZ VİDA & ÇARK

Worm Gear Set

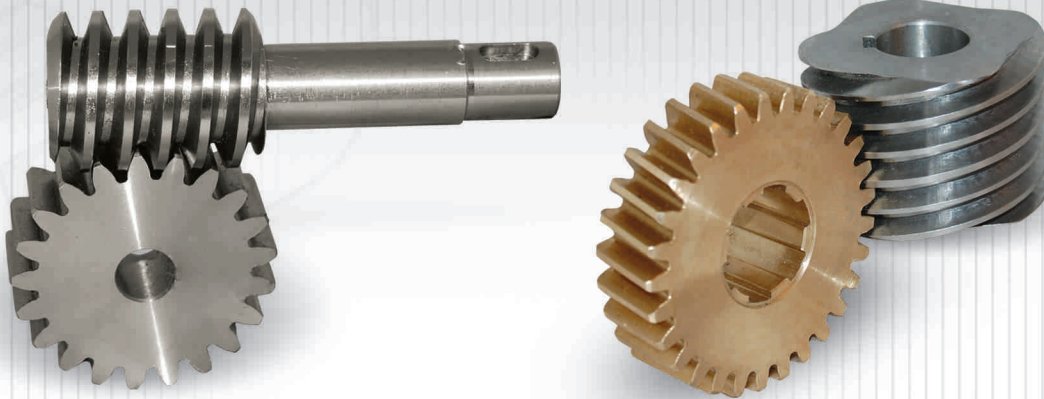

Özellikler / Specifications

Ürün Adı Product Name	SONSUZ VİDA & ÇARK / Worm Gear Set			
ÇARK / Gear	Min. Modül / Min. Module	1 MN.	Min. Çap / Min.Dia.	50 mm.
	Max. Modül / Max. Module	5 MN.	Max. Çap / Max.Dia.	300 mm.
VİDA / Worm	Min. Modül / Min. Module	1 MN.	Min. Çap / Min.Dia.	30 mm.
	Max. Modül / Max. Module	5 MN.	Max. Çap / Max.Dia.	150 mm.



Büsan Özel Organize Sanayi Bölgesi
Esenler Caddesi No.:43
Karatay / KONYA/TURKEY

Tel&Fax : +90 332 **345 13 89**

info@devrandisli.com

www.devrandisli.com

